



**HIGH ACCURACY**

m e a s u r e m e n t i n s t r u m e n t s

## PRODUCT DATASHEET

[www.high-accuracy.com](http://www.high-accuracy.com)

# Micro Motion<sup>®</sup> R-Series Coriolis Flow and Density Meters



## Multi-variable flow and density measurement

- Basic liquid mass flow, volume flow, and density measurement performance in a compact design
- Rugged design minimizing process, mounting, and environmental effects

## Best fit-for-application

- Cleanable, self-draining design for critical process control service
- Compact design enables installation flexibility and reduced maintenance costs
- Broad range of I/O offerings including HART, FOUNDATION<sup>™</sup> fieldbus, 4-20mA, and wireless capabilities

## Exceptional reliability and safety

- No moving parts to wear or replace minimizes maintenance for long-term reliability
- 316L stainless steel construction for compatibility with most fluids
- Robust sensor design minimizes down time and process interruption costs

## Micro Motion® R-Series flow meters

Micro Motion R-Series meters are designed for general utility use across a wide range of applications where basic flow and density measurements are needed. Benefiting from the fundamental advantages of Coriolis technology, the Micro Motion R-series is an ideal replacement for mechanical flow meters.

---

### Tip

If you need help determining which Micro Motion products are right for your application, check out the [Micro Motion® Technical Overview and Specification Summary](#) and other resources available at [www.emerson.com](http://www.emerson.com).

---

### Optimal flow measurement fit for general purpose applications

- Rugged measurement in a compact, drainable design that maximizes process up time
- Low frequency, high sensitivity fit-and-forget meter provides robust measurements even under demanding process conditions
- Multiple line sizes provide an ideal platform for batching, distribution, allocation and intra-plant measurement applications

### Industry-leading capabilities that unleash your process potential

- Available with an extensive offering of transmitter and mounting options for maximum compatibility with your system
- State of the art, ISO-IEC 17025 compliant calibration stands achieving  $\pm 0.014\%$  uncertainty drive best in class measurement accuracy
- The most robust communication protocol offering in the industry including Smart Wireless
- True multi-variable technology measures necessary flow process variables simultaneously

### Widest range of installation and process condition flexibility

- Featuring a low pressure drop, low weight design that reduces installation and commissioning costs
- Unmatched MVD transmitter technology with digital signal processing (DSP) delivers the fastest response rates enabling accurate batch and process measurement

## Measurement principles

As a practical application of the Coriolis effect, the Coriolis mass flow meter operating principle involves inducing a vibration of the flow tube through which the fluid passes. The vibration, though it is not completely circular, provides the rotating reference frame which gives rise to the Coriolis effect. While specific methods vary according to the design of the flow meter, sensors monitor and analyze changes in frequency, phase shift, and amplitude of the vibrating flow tubes. The changes observed represent the mass flow rate and density of the fluid.

### Mass flow measurement

The measuring tubes are forced to oscillate producing a sine wave. At zero flow, the two tubes vibrate in phase with each other. When flow is introduced, the Coriolis forces cause the tubes to twist resulting in a phase shift. The time difference between the waves is measured and is directly proportional to the mass flow rate.

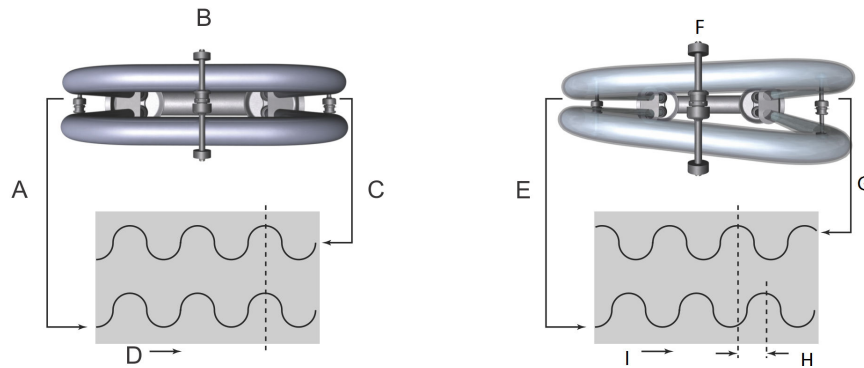

- A. Inlet pickoff displacement
- B. No flow
- C. Outlet pickoff displacement
- D. Time
- E. Inlet pickoff displacement
- F. With flow
- G. Outlet pickoff displacement
- H. Time difference
- I. Time

## Temperature measurement

Temperature is a measured variable that is available as an output. The temperature is also used internal to the sensor to compensate for temperature influences on Young's Modulus of Elasticity.

## Meter characteristics

- Measurement accuracy is a function of fluid mass flow rate independent of operating temperature, pressure, or composition. However, pressure drop through the sensor is dependent upon operating temperature, pressure, and fluid composition.
- Specifications and capabilities vary by model and certain models may have fewer available options. Please refer to the Online Store Sizing and Selection Tool at the Emerson web site ([www.micromotion.com/onlinestore](http://www.micromotion.com/onlinestore)) for detailed information regarding performance and capabilities.
- The letter at the end of the base model code (for example R100S) represents wetted part material and/or application designation: S = stainless steel and P = high pressure. Detailed information about the complete product model codes are described later in this document.

## Performance specifications

### Reference operating conditions

For determining the performance capabilities of our meters, the following conditions were observed/utilized:

- Water at 68 to 77 °F and 14.5 to 29 psig (20 to 25 °C and 1 to 2 barg)
- Air and Natural Gas at 68 to 77°F and 500 - 1450 psig (20 to 25 °C and 34 to 100 barg)
- Accuracy based on industry leading accredited calibration stands according to ISO 17025/IEC 17025
- All models have a density range up to 5 g/cm<sup>3</sup> (5000 kg/m<sup>3</sup>)

## Accuracy and repeatability

### Accuracy and repeatability on liquids and slurries

Performance Specification	Calibration code Y	Calibration code A
Mass flow accuracy <sup>(1)</sup>	±0.5% of rate	±0.4% of rate
Volume flow accuracy <sup>(1)</sup>	±0.5% of rate <sup>(2)</sup>	±0.4% of rate
Mass flow repeatability	0.25% of rate	0.2% of rate
Volume flow repeatability	0.25% of rate	0.2% of rate
Density accuracy	±0.01 g/cm <sup>3</sup> (±10.0kg/m <sup>3</sup> )	±0.003 g/cm <sup>3</sup> (±3.0kg/m <sup>3</sup> )
Density repeatability	0.005 g/cm <sup>3</sup> (5.0kg/m <sup>3</sup> )	0.0015 g/cm <sup>3</sup> (1.5kg/m <sup>3</sup> )
Temperature accuracy	±1 °C ±0.5% of reading	
Temperature repeatability	0.2 °C	

(1) Stated flow accuracy includes the combined effects of repeatability, linearity, and hysteresis.

(2) Valid at calibration conditions.

### Accuracy and repeatability on gases

Performance specification	All models
Mass flow accuracy <sup>(1)</sup>	±0.75% of rate
Mass flow repeatability	0.5% of rate
Temperature accuracy	±1 °C 0.5% of reading
Temperature repeatability	0.2 °C

(1) Stated flow accuracy includes the combined effects of repeatability, linearity, and hysteresis.

## Liquid flow rates

### Nominal flow rate

Micro Motion has adopted the term nominal flow rate, which is the flow rate at which water at reference conditions causes approximately 14.5 psig (1 barg) of pressure drop across the meter.

### Mass flow rates for all models: 316L stainless steel (S) and high pressure (P)

Model	Nominal line size		Nominal flow rate		Maximum flow rate	
	inch	mm	lb/min	kg/h	lb/min	kg/h
R025	1/4"	DN6	50	1,366	100	2,720
R050	1/2"	DN15	155	4,226	300	8,160
R100	1"	DN25	604	16,440	1,200	32,650
R200	2"	DN50	1,917	52,160	3,200	87,100

**Volume flow rates for all models: 316L stainless steel (S) and high pressure (P)**

Model	Nominal flow rate			Maximum flow rate		
	gal/min	barrels/h	l/h	gal/min	barrels/h	l/h
R025	6	9	1,366	12	23	2,720
R050	19	27	4,226	36	69	8,160
R100	72	103	16,440	144	274	32,650
R200	230	328	52,160	384	731	87,100

**Gas flow rates**

When selecting sensors for gas applications, pressure drop through the sensor is dependent upon operating temperature, pressure, and fluid composition. Therefore, when selecting a sensor for any particular gas application, it is highly recommended that each sensor be sized using the Online Store Sizing and Selection Tool at the Emerson web site ([www.micromotion.com/onlinestore](http://www.micromotion.com/onlinestore)).

The below table indicates flow rates that produce approximately 25psig (1.7barg) pressure drop on natural gas.

**Gas flow rates for all models: 316L stainless steel (S) and high pressure (P)**

Model	Mass		Volume	
	lb/min	kg/h	SCFM	Nm <sup>3</sup> /h
R025	17	468	388	659
R050	52	1,429	1,183	2,010
R100	200	5,452	4,514	7,670
R200	666	18,137	15,018	25,515

**Note**

Standard (SCFM) reference conditions are 14.7 psig and 60 °F. Normal reference conditions are 1.013 barg and 0 °C.

**Zero stability**

Zero stability is used when the flow rate approaches the low end of the flow range where the meter accuracy begins to deviate from the stated accuracy rating, as depicted in the turndown section below. When operating at flow rates where meter accuracy begins to deviate from the stated accuracy rating, accuracy is governed by the formula: accuracy = (zero stability/flow rate) x 100%. Repeatability is similarly affected by low flow conditions.

**Turndown capabilities**

The graph and table below represent an example of the measurement characteristics under various flow conditions. At flow rates requiring large turndowns (greater than 20:1), the zero stability values may begin to govern capability dependent upon flow conditions and meter in use.

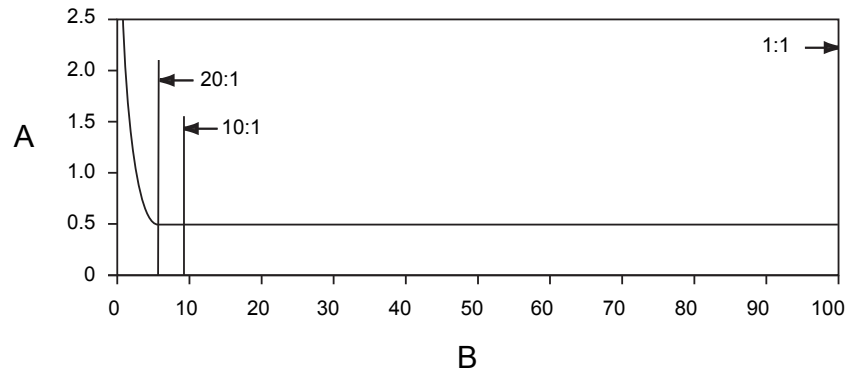

A. Accuracy, %  
 B. Flow rate, % of nominal

Turndown from nominal flow rate		20:1	10:1	1:1
Accuracy	±%	0.50	0.50	0.50
Pressure drop	psig (barg)	0.1 (0.007)	0.813 (0.05)	54 (3.4)

**Zero stability for all models: 316L stainless steel (S) and high pressure (P)**

Model	Zero stability	
	lb/min	kg/h
R025	0.0061	0.165
R050	0.0180	0.492
R100	0.0750	2.046
R200	0.2398	6.540

**Process pressure ratings**

Sensor maximum working pressure reflects the highest possible pressure rating for a given sensor. Process connection type and environmental and process fluid temperatures may reduce the maximum rating. Refer to the Technical Data Sheet for common sensor and fitting combinations.

All sensors comply with Council Directive 2014/68/EU on pressure equipment.

**Note**

R-Series sensors with JIS process connections do not comply with ASME B31.1 power piping code.

**Sensor maximum working pressure for all models: 316L stainless steel (S) and high pressure (P)**

Model	psig	barg
All stainless steel models (R025S–R200S)	1,450	100
R025P	2,300	159

## Case pressure

### Case pressure for all models: 316L stainless steel (S) and high pressure (P)

Model	Case maximum pressure <sup>(1)</sup>		NAMUR NE132		Typical burst pressure	
	psig	barg	psig	barg	psig	barg
R025	166	11	1,256	87	1,884	130
R050	135	9	1,020	70	1,530	105
R100	109	7	854	59	1,281	88
R200	64	4	507	35	760	52

(1) One time case containment pressure over a period of a maximum of 50 hours.

## Operating conditions: Environmental

### Vibration limits

Meets IEC 68.2.6, endurance sweep, 5 to 2000 Hz, 50 sweep cycles at 1.0 g.

### Temperature limits

Sensors can be used in the process and ambient temperature ranges shown in the temperature limit graphs. For the purposes of selecting electronics options, temperature limit graphs should be used only as a general guide. If your process conditions are close to the gray area, consult with your Micro Motion representative.

#### Note

- In all cases, the electronics cannot be operated where the ambient temperature is below  $-40^{\circ}\text{F}$  ( $-40^{\circ}\text{C}$ ) or above  $+140^{\circ}\text{F}$  ( $+60^{\circ}\text{C}$ ). If a sensor is to be used where the ambient temperature is outside of the range permissible for the electronics, the electronics must be remotely located where the ambient temperature is within the permissible range, as indicated by the shaded areas of the temperature limit graphs.
- Temperature limits may be further restricted by hazardous area approvals. Refer to the hazardous area approvals documentation shipped with the sensor or available at [www.emerson.com](http://www.emerson.com).
- The extended-mount electronics option allows the sensor case to be insulated without covering the transmitter, core processor, or junction box, but does not affect temperature ratings. When insulating the sensor case at elevated process temperatures (above  $140^{\circ}\text{F}$ ), please ensure electronics are not enclosed in insulation as this may lead to electronics failure.

**Ambient and process temperature limits for all models: 316L stainless steel (S) and high pressure (P)**

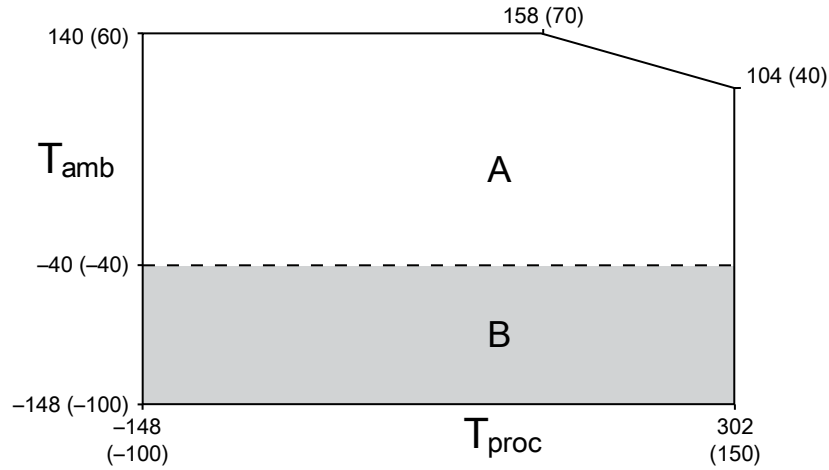

$T_{amb}$  = Ambient temperature °F (°C)  
 $T_{proc}$  = Process temperature °F (°C)  
 A = All available electronic options  
 B = Remote mount electronics only

## Operating conditions: Process

### Process temperature effect

- For mass flow measurement, process temperature effect is defined as the change in sensor flow accuracy due to process temperature change away from the calibration temperature. Temperature effect can be corrected by zeroing at the process conditions.

**Process temperature effect for all models: 316L stainless steel (S) and high pressure (P)**

Model code	Mass flow rate (% of maximum rate) per °C	Density	
		g/cm <sup>3</sup> per °C	kg/m <sup>3</sup> per °C
R025, R050, R100, R150, R200, R300	±0.00175	±0.0001	±0.1

### Process pressure effect

Process pressure effect is defined as the change in sensor flow accuracy due to process pressure change away from the calibration pressure. This effect can be corrected by dynamic pressure input or a fixed meter factor. See installation manual for proper setup and configuration.

**Process pressure effect for all models: 316L stainless steel (S) and high pressure (P)**

Model code	Liquid or gas flow (% of rate)		Density	
	per psig	per barg	g/cm <sup>3</sup> per psig	kg/m <sup>3</sup> per barg
R025, R050, R100, R150	none	none	none	none

Model code	Liquid or gas flow (% of rate)		Density	
	per psig	per barg	g/cm <sup>3</sup> per psig	kg/m <sup>3</sup> per barg
R200, R300	-0.001	-0.015	-0.00003	-0.43

## Pressure relief

R-Series sensors are available with a rupture disk installed on the case. Rupture disks are meant to vent process fluid from the sensor case in the unlikely event of a flow tube breach. Some users connect a pipeline to the rupture disk to help contain escaping process fluid. For more information about rupture disks, contact Micro Motion Customer Service.

If the sensor has a rupture disk, it should remain installed at all times as it would otherwise be necessary to re-purge the case. If the rupture disk is activated by a tube breach, the seal in the rupture disk will be broken, and the Coriolis meter should be removed from service.

The rupture disk is located as follows on the meter, and the warning sticker shown is placed next to it.

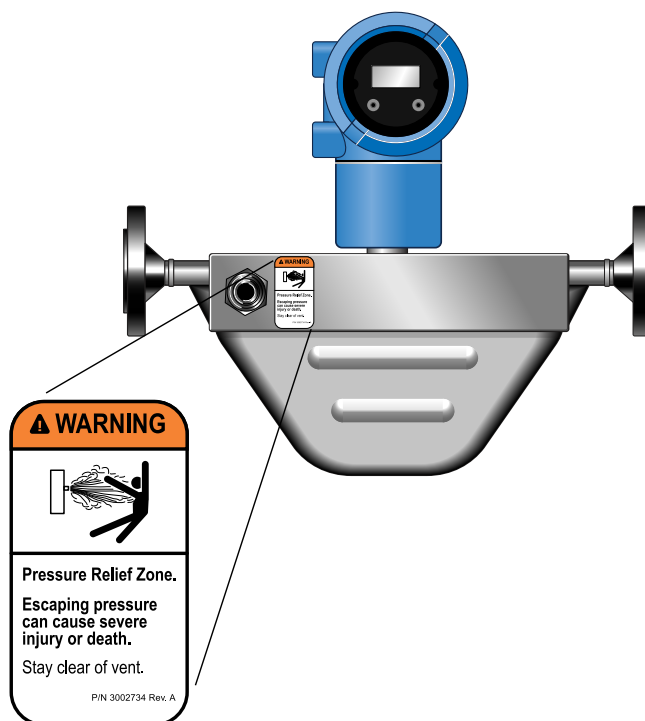

### **⚠ DANGER!**

Stay clear of the rupture disk pressure relief area. High-pressure fluid escaping from the sensor can cause severe injury or death.

The sensor must be oriented so that personnel and equipment will not be exposed to any discharge along the pressure relief path.

### **Important**



If a rupture disk is used, the housing can no longer assume a secondary containment function.

**⚠ WARNING!**

Removing the Purge Fitting, Blind Plug, or Rupture Disks compromises the Ex-i Safety Certification, the Ex-tc Safety Certification, and the IP-rating of the Coriolis meter. Any modification to the Purge Fitting, Blind Plug, or Rupture Disks must maintain a minimum of IP66/IP67 Ratings.

## Hazardous area classifications

### Approvals and certifications

Type	Approval or certification (typical)	
CSA and CSA C-US	Ambient temperature: -40 to +140 °F (-40 to +60 °C) Class I, Div. 1, Groups C and D Class I, Div. 2, Groups A, B, C, and D Class II, Div.1, Groups E, F, and G	
ATEX		II 2G Ex ib IIB/IIC T1-T4/T5/T6 Gb II 2D Ex ib IIIC T(1)°C Db IP65
		II 3G Ex nA IIC T1-T4/T5 Gc II 3D Ex tc IIIC T(1) °C Dc IP66
IECEX	Ex ib IIB/IIC T1-T4/T5/T6 Gb Ex nA IIC T1-T4/T5 Gc	
NEPSI	Ex ib IIB/IIC T1-T6 Gb Ex ibD 21 T450°C-T85°C Ex nA IIC T1-T6 Gc DIP A22 T(1) T1-T6	
Ingress Protection Rating	IP 66/67 for sensors and transmitters	
EMC effects	Complies with EMC directive 2004/108/EC per EN 61326 Industrial	
	Complies with NAMUR NE-21 (22.08.2007)	

#### Note

- Approvals shown are for R-Series meters configured with a model 1700 transmitter. Meters with integral electronics may have more restrictive approvals. Refer to the Product Data Sheet for each transmitter for details.
- When a meter is ordered with hazardous area approvals, detailed information is shipped along with the product.
- More information about hazardous approvals, including detailed specifications and temperature graphs for all meter configurations is available on the R-Series product page from the Emerson web site ([www.emerson.com](http://www.emerson.com)).

### Industry standards

Type	Standard
Industry standards and commercial approvals	<ul style="list-style-type: none"> <li>■ NAMUR: NE132 (burst pressure, sensor flange to flange length), NE131</li> <li>■ Pressure Equipment Directive (PED)</li> <li>■ Canadian Registration Number (CRN)</li> <li>■ Dual Seal</li> <li>■ ASME B31.3 Piping Code</li> <li>■ SIL2 and SIL3 safety certifications</li> </ul>

## Transmitter interface

A Micro Motion flowmeter system is highly customizable to provide a configuration that is tailor-fit to specific applications.

Robust transmitter offerings allow a multitude of mounting options:

- Compact mounting integral to the sensor
- Field mount variants for harsh conditions
- Compact control room DIN rail packages for optimal locating in a control cabinet
- Specific fit-for-purpose solutions for two-wire connectivity or filling and dosing machinery integration

Micro Motion meters are available with an expansive selection of input and output connectivity options including the following:

- 4-20 mA
- HART™
- WirelessHART™
- FOUNDATION™ fieldbus
- Modbus®
- Other protocols may be available on request

## Physical specifications

### Materials of construction

General corrosion guidelines do not account for cyclical stress, and therefore should not be relied upon when choosing a wetted material for a Micro Motion meter. Please refer to the [Micro Motion Corrosion Guide](#) for material compatibility information.

#### Wetted part materials

Model	Material options	Sensor weight	
	316L Stainless steel	lb	kg
R025	R025S and R025P	10	5
R050	R050S	11	5
R100	R100S	21	10
R150	R150S	26	12
R200	R200S	42	20
R300	R300S	105	48

#### Note

- Weight specifications are based upon ASME B16.5 CL150 flange and do not include electronics.
- Heat jackets and steam kits are also available.

#### Non-wetted part materials

Component	Enclosure rating	316L stainless steel	304L stainless steel	Polyurethane-painted aluminum
Sensor housing	—		•	
Core processor housing	NEMA 4X (IP66/67)	•		•

Component	Enclosure rating	316L stainless steel	304L stainless steel	Polyurethane-painted aluminum
Model 1700/2700 transmitter housing	NEMA 4X (IP66)	•		•

## Flanges

Sensor type	Flange types
Stainless steel 316L	<ul style="list-style-type: none"> <li>■ ASME B16.5 weld neck flange (up to CL600)</li> <li>■ ASME B16.5 weld neck flange raised face (up to CL600)</li> <li>■ EN 1092-1 weld neck flange form B1, B2, D (up to PN100)</li> <li>■ JIS B2220 weld neck raised face (up to 20K)</li> <li>■ VCO, VCR swagelok compatible fitting</li> <li>■ Hygienic tri-clamp compatible</li> </ul>

### Note

For flange compatibility, please refer to the Online Store Sizing and Selection Tool at the Emerson web site ([www.micromotion.com/onlinestore](http://www.micromotion.com/onlinestore)).

## Dimensions

These dimensional drawings are intended to provide a basic guideline for sizing and planning. They are representative of a 316 stainless steel model fitted with ASME B16.5 CL150 flange, and 1700 transmitter.

Face-to-Face (Dim. A, below) dimensions for all R-series meters with each available process connection can be found in the R-series Technical Data Sheet.

Complete and detailed dimensional drawings can be found through the product link in our online store ([www.micromotion.com/onlinestore](http://www.micromotion.com/onlinestore)).

### Note

- All dimensions  $\pm 1/8$  inch ( $\pm 3$  mm).
- Representative of a 316 stainless steel model fitted with ASME B16.5 CL150 flange, and 1700 transmitter

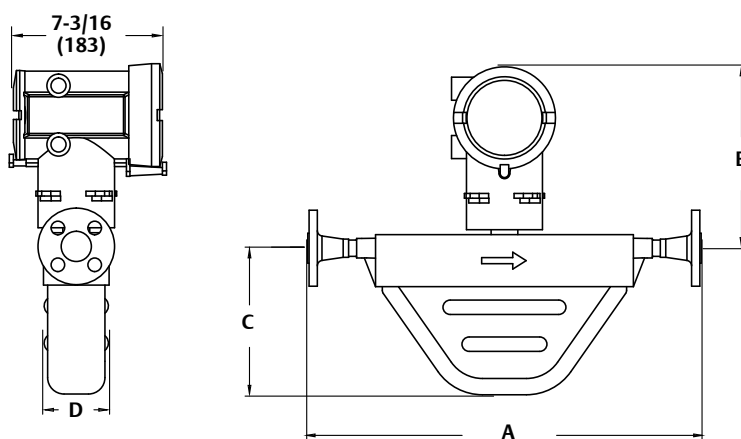
**Example dimensions for all models: 316L stainless steel (S), and high pressure (P)**

Model	Dim. A		Dim. B		Dim. C		Dim. D	
	Inch	mm	Inch	mm	Inch	mm	Inch	mm
R025	16	406	8-3/8	213	5-1/8	130	2-13/16	71
R050	18-1/8	460	8-3/8	213	6-3/4	171	2-15/16	75
R100	22-11/16	576	8-5/8	219	9-1/8	232	4-1/8	105
R150	20-1/4	514	7-3/4	198	8-3/4	225	3-1/2	88
R200	24-3/4	629	9-9/16	267	12-9/16	319	5-5/8	143
R300	34-3/4	881	9-7/8	250	11-1/16	281	7-1/3	186

## Ordering information

### Model code structure

A complete sensor model code includes the ordering options.

Example code	Description
R	Sensor type
025	Model — <i>Base model</i>
S	Model type — <i>Base model</i>
113	<i>Process connections</i>
N	<i>Case options</i>
C	<i>Electronics interface</i>
A	<i>Conduit connections</i>
M	<i>Approvals</i>
E	<i>Languages</i>
Y	<i>Calibration</i>

Example code	Description
Z	<a href="#">Future option 1</a>
Z	<a href="#">Measurement application software</a>
Z	<a href="#">Factory options</a>

## Base model

### Codes available by model

Codes S and P are model designations used to identify the type of meter.

Model	Available codes	
	S <sup>(1)</sup>	P <sup>(2)</sup>
R025 1/4-inch (6 mm)	S	P
R050 1/2-inch (12 mm)	S	
R100 1-inch (25 mm)	S	
R200 2-inch (50 mm)	S	

(1) 316 stainless steel

(2) High pressure

## Process connections

### Model R025S

Code	Description					
113	1/2-inch	CL150	ASME B16.5	F316/F316L	Weld neck flange	Raised face
114	1/2-inch	CL300	ASME B16.5	F316/F316L	Weld neck flange	Raised face
115	1/2-inch	CL600	ASME B16.5	F316/F316L	Weld neck flange	Raised face
116	DN15	PN40	DIN 2635	F316/F316L	Weld neck flange	Form C face
120	DN15	PN100/160	DIN 2638	F316/F316L	Weld neck flange	Form E face
121	1/2-inch		Tri-Clamp compatible	316L	Hygienic fitting	
122	15mm	20K	JIS B 2220	F316/316L	Weld neck flange	Raised face
170	DN15	PN100/160	EN 1092-1	F316/F316L	Weld neck flange	Type B2
172	DN25	PN40	EN 1092-1	F316/F316L	Weld neck flange	Type B1
176	DN15	PN40	EN 1092-1	F316/F316L	Weld neck flange	Type B1
178	DN15	PN100	EN 1092-1	F316/F316L	Weld neck flange	Type D
183	DN25	PN40	EN 1092-1	F316/F316L	Weld neck flange	Type D
221	15mm	40K	JIS B 2220	F316/316L	Weld neck flange	Raised face
222	DN15		DIN11851	316/316L	Hygienic coupling	
310	DN15	PN40	EN 1092-1	F316/F316L	Weld neck flange	Type D

Code	Description					
319	#8		VCO	316/316L	Swagelok compatible fitting	1/2-inch NPT female adapter

**Model R025P**

Code	Description					
120	DN15	PN100/160	DIN 2638	F316/F316L	Weld neck flange	Type E face
170	DN15	PN100/160	EN 1092-1	F316/F316L	Weld neck flange	Form B2
178	DN15	PN100	EN 1092-1	F316/F316L	Weld neck flange	Form D
180	DN25	PN100	EN 1092-1	F316/F316L	Weld neck flange	Form B2
319	#8		VCO	316/316L	Swagelok compatible fitting	1/2-inch NPT female adapter

**Model R050S**

Code	Description					
113	1/2-inch	CL150	ASME B16.5	F316/F316L	Weld neck flange	Raised face
114	1/2-inch	CL300	ASME B16.5	F316/F316L	Weld neck flange	Raised face
115	1/2-inch	CL600	ASME B16.5	F316/F316L	Weld neck flange	Raised face
116	DN15	PN40	DIN 2635	F316/F316L	Weld neck flange	Form C face
120	DN15	PN100/160	DIN 2638	F316/F316L	Weld neck flange	Form E face
122	15mm	20K	JIS B 2220	F316/316L	Weld neck flange	Raised face
131	DN25	PN40	DIN 2635	F316/F316L	Weld neck flange	Form C face
170	DN15	PN100/160	EN 1092-1	F316/F316L	Weld neck flange	Type B2
172	DN25	PN40	EN 1092-1	F316/F316L	Weld neck flange	Type B1
176	DN15	PN40	EN 1092-1	F316/F316L	Weld neck flange	Type B1
178	DN15	PN100	EN 1092-1	F316/F316L	Weld neck flange	Type D
183	DN25	PN40	EN 1092-1	F316/F316L	Weld neck flange	Type D
221	15mm	40K	JIS B 2220	F316/316L	Weld neck flange	Raised face
222	DN15		DIN11851	316/316L	Hygienic coupling	
239	#12		VCO	316/316L	Swagelok compatible fitting	3/4-inch NPT female adapter
310	DN15	PN40	EN 1092-1	F316/F316L	Weld neck flange	Type D
322	3/4-inch		Tri-Clamp compatible	316L	Hygienic fitting	

**Model R100S**

Code	Description					
128	1-inch	CL150	ASME B16.5	F316/F316L	Weld neck flange	Raised face
129	1-inch	CL300	ASME B16.5	F316/F316L	Weld neck flange	Raised face
130	1-inch	CL600	ASME B16.5	F316/F316L	Weld neck flange	Raised face
131	DN25	PN40	DIN 2635	F316/F316L	Weld neck flange	Form C face
137	DN25	PN100/160	DIN 2638	F316/F316L	Weld neck flange	Form E face

Code	Description					
138	1-inch		Tri-Clamp compatible	316L	Hygienic fitting	
139	25mm	20K	JIS B 2220	F316/F316L	Weld neck flange	Raised face
179	DN25	PN40	EN 1092-1	F316/F316L	Weld neck flange	Type B1
180	DN25	PN100	EN 1092-1	F316/F316L	Weld neck flange	Type B2
181	DN25	PN100	EN 1092-1	F316/F316L	Weld neck flange	Type D
229	25mm	40K	JIS B 2220	F316/316L	Weld neck flange	Raised face
230	DN25		DIN11851	316/316L	Hygienic coupling	
311	DN25	PN40	EN 1092-1	F316/F316L	Weld neck flange	Type D

**Model R200S**

Code	Description					
312	DN40	PN40	EN 1092-1	F316/F316L	Weld neck flange	Type D
316	DN50	PN40	EN 1092-1	F316/F316L	Weld neck flange	Type D
341	1-1/2-inch	CL150	ASME B16.5	F316/F316L	Weld neck flange	Raised face
342	1-1/2-inch	CL300	ASME B16.5	F316/F316L	Weld neck flange	Raised face
343	1-1/2-inch	CL600	ASME B16.5	F316/F316L	Weld neck flange	Raised face
351	1-1/2-inch		Tri-Clamp compatible	316L	Hygienic fitting	
352	2-inch		Tri-Clamp compatible	316L	Hygienic fitting	
353	DN40		DIN11851	316/316L	Hygienic coupling	
363	DN40	PN100	EN 1092-1	F316/F316L	Weld neck flange	Type B2
365	DN50	PN100	EN 1092-1	F316/F316L	Weld neck flange	Type B2
366	DN40	PN100	EN 1092-1	F316/F316L	Weld neck flange	Type D
367	DN50	PN100	EN 1092-1	F316/F316L	Weld neck flange	Type D
368	DN40	PN40	EN 1092-1	F316/F316L	Weld neck flange	Type B1
369	DN50	PN40	EN 1092-1	F316/F316L	Weld neck flange	Type B1
378	DN50	PN100	DIN 2637	F316/F316L	Weld neck flange	Form E face
381	DN40	PN40	DIN 2635	F316/F316L	Weld neck flange	Form C face
382	DN50	PN40	DIN 2635	F316/F316L	Weld neck flange	Form C face
385	40mm	10K	JIS B 2220	F316/F316L	Weld neck flange	Raised face
386	50mm	10K	JIS B 2220	F316/316L	Weld neck flange	Raised face
387	40mm	20K	JIS B 2220	F316/F316L	Weld neck flange	Raised face
388	50mm	20K	JIS B 2220	F316/316L	Weld neck flange	Raised face
418	2-inch	CL150	ASME B16.5	F316/F316L	Weld neck flange	Raised face
419	2-inch	CL300	ASME B16.5	F316/F316L	Weld neck flange	Raised face

Code	Description					
420	2-inch	CL600	ASME B16.5	F316/F316L	Weld neck flange	Raised face

## Case options

Code	Case option
N	Standard case
D <sup>(1)</sup>	Compact case with rupture disk (1/2-inch NPT male)
P <sup>(1)</sup>	Compact case with purge fittings (1/2-inch NPT female)

(1) Not available with approval T, S, or J.

## Electronics interface

Code	Case option
Q	4-wire epoxy-painted aluminum integral core processor for remotely mounted transmitter with MVD technology
A	4-wire stainless steel integral core processor for remotely mounted transmitter with MVD technology
V	4-wire epoxy-painted aluminum integral core processor with extended mount for remotely mounted transmitter with MVD technology
B	4-wire stainless steel integral core processor with extended mount for remotely mounted transmitter with MVD technology
C	Integrally mounted Model 1700 or 2700 transmitter.
W <sup>(1)</sup>	MVDSolo; epoxy-painted aluminum integral core processor for direct host connection (for (OEMs))
D <sup>(1)</sup>	MVDSolo; stainless steel integral core processor for direct host connection (for (OEMs))
Y <sup>(1)</sup>	MVDSolo; extended-mount epoxy-painted aluminum integral core processor (for (OEMs))
E <sup>(1)</sup>	MVDSolo; extended-mount stainless steel integral core processor for (OEMs)

(1) When electronics interface code W, D, Y, or E is ordered with approval code C, A, or Z, MVD Direct Connect™ I.S. barrier is supplied.

## Conduit connections

### Code descriptions

Code	Description
A	No gland
B	1/2-inch NPT - no gland
E	M20 - no gland
F	Brass/nickel cable gland (cable diameter 0.335 to 0.394 inches [8.5 to 10 mm])
G	Stainless steel cable gland (cable diameter 0.335 to 0.394 inches [8.5 to 10 mm])
K	JIS B0202 1/2G - no gland
L	Japan - brass nickel cable gland
M	Japan - stainless steel gland

**Codes available by model**

Model	Available codes							
	M	L	K	G	F	E	B	A
All models with electronics interface codes Q, A, V, and B	M	L	K	G	F	E	B	
All models with electronics interface code C								A
All models with electronics interface codes W, D, Y, and E				G	F	E	B	

**Approvals****Code descriptions**

Code	Description
M	Micro Motion Standard (no approval)
N	Micro Motion Standard / PED compliant
C	CSA (Canada only)
A	CSA (US and Canada): Class I, Division 1, Groups C and D
Z	ATEX - Equipment Category 2 (Zone 1) / PED compliant
I	IECEX Zone 1
P	NEPSI; only available with language option M (Chinese)
T	TIIS - T4 Temperature Classification (Not available for quotes outside of Japan) N/C
S	TIIS - T3 Temperature Classification (Not available for quotes outside of Japan)
L	TIIS - T2 Temperature Classification (Not available for quotes outside of Japan)
J	Hardware ready for TIIS approval (EPM Japan only)

**Codes available by model**

Model	Available codes										
	J	S	T	P	I	Z	A	C	N	M	
With electronics interface codes Q, A, V, B, and C	J	S	T	P	I	Z	A	C	N	M	
With electronics interface codes W, D, Y, and E				P		Z	A	C	N	M	

**Languages**

A	Danish CE requirements document and English installation manual
C	Czech installation manual
D	Dutch CE requirements document and English installation manual
E	English installation manual
F	French installation manual
G	German installation manual
H	Finnish CE requirements document and English installation manual

I	Italian installation manual
J	Japanese installation manual
M	Chinese installation manual
N	Norwegian CE requirements document and English installation manual
O	Polish installation manual
P	Portuguese installation manual
S	Spanish installation manual
W	Swedish CE requirements document and English installation manual
B	Hungarian CE requirements document and English installation manual
K	Slovak CE requirements document and English installation manual
T	Estonian CE requirements document and English installation manual
U	Greek CE requirements document and English installation manual
L	Latvian CE requirements document and English installation manual
V	Lithuanian CE requirements document and English installation manual
Y	Slovenian CE requirements document and English installation manual

## Calibration

Code	Calibration option
Y	0.5% mass flow and 0.01 g/cm <sup>3</sup> (10 kg/m <sup>3</sup> ) density calibration (±0.5% volume flow)
A	0.4% mass flow and 0.003 g/cm <sup>3</sup> (3.0 kg/m <sup>3</sup> ) density calibration (±0.5% volume flow)
Z	0.5% mass flow calibration

## Future option 1

Code	Future option 1
Z	Reserved for future use

## Measurement application software

Code	Measurement application software option
Z	No measurement application software

## Factory options

Code	Factory option
Z	Standard product
X	ETO product

Code	Factory option
R	Restocked product (if available)

## Certificates, tests, calibrations, and services

These option codes can be added to the end of the model code if needed, but no code is required when none of these options is selected.

### Note

There may be additional options or limitations depending on total meter configuration. Contact a sales representative before making your final selections.

### Material quality examination tests and certificates

Select any from this group.

Code	Factory option
MC	Material inspection certificate 3.1 (supplier lot traceability per EN 10204)
NC	NACE certificate 2.1 (MR0175 and MR0103)
KH	KHK package 3.1 — certificate package to accommodate approval in Japan. Includes: <ul style="list-style-type: none"> <li>■ Radiographic and tube wall examination</li> <li>■ HSB witness primary containment hydrostatic and pneumatic testing</li> <li>■ Material inspection certificate</li> </ul> Not available with optional feature codes RE, RT, HT, MC (because they are already included)

### Radiographic testing

Select only one from this group.

Code	Factory option
RE	X-ray package 3.1 (radiographic examination certificate; weld map; radiographic inspection NDE qualification)
RT	X-Ray package 3.1 (radiographic examination certificate with digital image; weld map; radiographic inspection NDE qualification)

### Pressure testing

Code	Factory option
HT	Hydrostatic test certificate 3.1 (wetted components only)

### Dye penetrant examination

Select any from this group.

Code	Factory option
D1	Dye penetrant test package 3.1 (sensor only, liquid dye penetration NDE qualification)

**Weld examination**

Code	Factory option
WP	Weld procedure package (weld map, weld procedure specification, weld procedure qualification record, welder performance qualification)

**Positive material testing**

Select only one from this group.

Code	Factory option
PM	Positive material test certificate 3.1 (without carbon content)
PC	Positive material test certificate 3.1 (including carbon content)

**ASME B31.1 Compliance options**

Code	Factory option
GC	B31.1 General compliance (not available with JIS flange options)

**Special cleaning**

Code	Factory option
O2	Declaration of compliance oxygen service 2.1

**Metrology compliance**

Code	Factory option
GR	Russian metrology calibration verification certificate

**Sensor completion**

Select any from this group.

Code	Factory option
WG	Witness general
SP	Special packaging

**Country specific approvals**

Select one from the following if approval code G is selected.

Code	Factory option
R1	EAC Zone 1 – Hazardous Approval <sup>(1)</sup>
B1	INMETRO Zone 1 – Hazardous Approval <sup>(1)</sup>

(1) Only available with approval code G.



















# HIGH ACCURACY

measurement instruments

Our offering:

	<p>Pressure Measurement</p>		<p>Level Measurement</p>
	<p>Temperature Measurement</p>		<p>Flow Measurement</p>
	<p>Marine Measurement &amp; Analytical</p>		<p>Gas Analysis</p>
	<p>Liquid Analysis</p>		<p>Flame and Gas Detection</p>
	<p>Tank Gauging</p>		<p>Wireless Infrastructure</p>
	<p>Acoustic &amp; Discrete</p>		

[www.high-accuracy.com](http://www.high-accuracy.com)

**Emerson Automation Solutions**

Worldwide Headquarters  
7070 Winchester Circle  
Boulder, Colorado USA 80301  
T: +1 800-522-6277  
T: +1 303-527-5200  
F: +1 303-530-8459  
Mexico: 52 55 5809 5300  
Argentina: 54 11 4837 7000  
Brazil: 55 15 3413 8147  
Chile: 56 2 2928 4800

**Emerson Automation Solutions**

Central Europe: +41 41 7686 111  
Eastern Europe: +41 41 7686 111  
Dubai: +971 4 811 8100  
Abu Dhabi: +971 2 697 2000  
France: 0800 917 901  
Germany: +49 (0) 2173 3348 0  
Italy: 8008 77334  
The Netherlands: +31 (0) 70 413 6666  
Belgium: +32 2 716 77 11  
Spain: +34 913 586 000  
U.K.: 0870 240 1978  
Russian/CIS: +7 495 981 9811

**Emerson Automation Solutions**

Australia: (61) 3 9721 0200  
China: (86) 21 2892 9000  
India: (91) 22 6662 0566  
Japan: (81) 3 5769 6803  
South Korea: (82) 31 8034 0000  
Singapore: (65) 6 363 7766

©2018 Micro Motion, Inc. All rights reserved.

The Emerson logo is a trademark and service mark of Emerson Electric Co. Micro Motion, ELITE, ProLink, MVD and MVD Direct Connect marks are marks of one of the Emerson Automation Solutions family of companies. All other marks are property of their respective owners.