



HIGH ACCURACY

m e a s u r e m e n t i n s t r u m e n t s

PRODUCT DATASHEET

www.high-accuracy.com

Rosemount™ 328A

Steam Sterilizable pH sensor



A robust pH sensor that meets steam sterilization requirements

The Rosemount 328A pH sensors are specifically built for service in applications that require repeated steam sterilization up to 130 °C. Sensors are suitable for use in many food, beverage, and pharmaceutical applications.

Overview



Rugged Sensor Design

- Mechanical and thermal shock resistant special pH sensitive glass membrane for extended sensor life in high temperature sterilizations.
- Non-flowing junction minimizes maintenance requirements and eliminates the need for expensive pressurization hardware.
- Extend sensor life with poisoning ion resistant double junction reference cell.
- Ceramic body and high temperature cable permits autoclave sterilization up to 130 °C.

Versatile Installation Options

- Designed to fit industry standard insertion hardware.
- 12 mm electrode diameter allows direct replacement of most manufacturers' steam sterilizable pH sensors.

Contents

Overview	2	Product Certifications	5
Ordering Information	3	Dimensional and Installation Drawings	6
Specifications	4	Accessories	7

Ordering Information



The Rosemount 328A pH sensor comes with 15 ft. of integral cable and features a ceramic sensor body, double junction reference, and gelled reference electrolyte. Sensors require standard insertion mounting hardware for installation (PN 22924-00; sold separately).

Table 1. Rosemount 328A pH Sensor ordering information

Model	Sensor type
328A	pH Sensor
Cable Termination	
07	Spade Lug Connector
08	None (Undressed)
Typical Model Number: 328A-07	

Specifications

Table 2. Rosemount 328A pH sensor specifications

Process Connections	
Standard 12 mm insertion hardware (see Dimensional Drawing)	
Sensitivity	
± 0.02pH	
Temperature/Pressure Rating	
446 kPa abs at 130 °C (50 psig at 266 °F)	
584 kPa abs at 80 °C (70 psig at 176 °F)	
791 kPa abs at 40 °C (100 psig at 104 °F)	
Cable	
2-conductor, low-noise coax, 15 ft (4.5 m)	
Weight/Shipping Weight	
100 gms/180 gms (.2 lb/1.0 lb)	
Performance	
In typical applications, the sensor will perform continuously for 50 steam sterilization cycles.	
pH Range	
1.67-4.01 pH	96% linearity
4.01-12.0	99% linearity
12.0-13.0 pH	97% linearity
Repeatability	
± 0.05 pH	
Automatic Temperature Compensation	
Temperature compensation is generally not required since most applications operate very near pH 7 (isopotential point). When temperature compensation is required a separate RTD can be used with compatible instruments.	
Wetted Materials	
Ceramic, silicone and glass	
Recommended Accessories	
PN 22924-00	25mm Insertion Mounting Adapter Kit

Product Certifications

Please see online certificates for further details.

IECEX

Ex ia IIC T4 Ga (-20 °C ≤ Ta ≤ +60 °C)

Per standards IEC60079-0: 2011, IEC 60079-11: 2011

ATEX

–  II 1 G Ex ia IIC T4 Ga (-20 °C ≤ Ta ≤ +60 °C)

Per standards EN 60079-0: 2012 + A11:2013, EN 60079-11:2012

FM

Intrinsically Safe for use in Class I, II, and III, Division 1, Groups A, B, C, D, E, F, and G; Temperature Class T6 Ta = -20 °C to +60 °C

Intrinsically Safe for use in Class I, Zone 0, AEx ia IIC T6 Ta = -20 °C to +60 °C

Nonincendive for use in Class I, Division 2, Groups A, B, C, and D; Temperature Class T6 Ta = -20 °C to +60 °C

Suitable for use in Class II and III, Division 2, Groups E, F, and G; Temperature Class T6 Ta = -20 °C to +60 °C Hazardous (Classified) Locations

IS/I,II,III/1/ABCDEFG/T6 Ta = 60 °C - 1400332; Entity; I/0/AEx ia IIC/T6 Ta = 60 °C - 1400332; Entity; NI/I/2/ABCD/T6 Ta = 60 °C; S/II,III/2/EFG/T6 Ta = 60 °C

Per standards 3600:1998, 3610:2010, 3611:2004, 3810:2005

CSA

Intrinsically Safe and Non-Incendive:

Class I, Division 1, Groups ABCD; Class II, Division 1, Groups EFG; Class III; Class I, Division 2, Groups ABCD; Ex ia IIC; T6; Ambient temperature rating -20 °C to +60 °C: (Simple Apparatus)

Per standards C22.2 No. 142 – M1987, C22.2 No 157 – M1992, CAN/CSA E60079-0:07, CAN/CSA E60079-11:02, UL 50:11th Ed., UL 508:17th Ed., UL 913: 7th Ed., UL 60079-0: 2005, UL 60079-11: 2002

Dimensional and Installation Drawings

Figure 1. Dimensional drawing of Rosemount 328A and optional mounting adapter hardware kit (PN 22924-00)

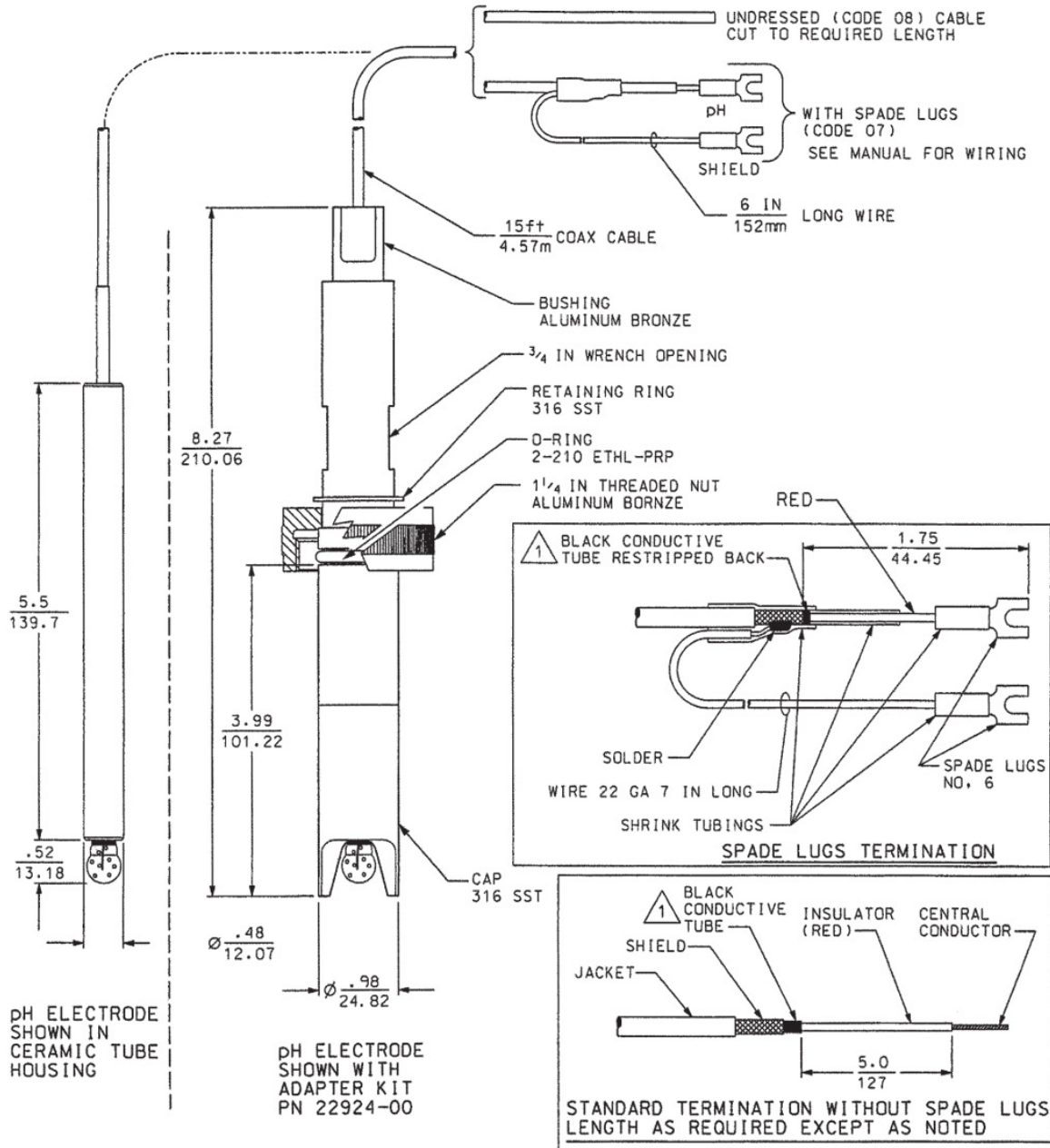

⚠ CAUTION:
CONDUCTIVE TUBE CANNOT BE NEAR SPADE
LUG OR TOUCH CENTRAL CONDUCTOR.

Accessories

Table 3. Rosemount 328A pH Sensor accessories information









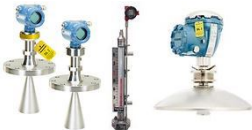

Part number	Description
22924-00	Sensor Mounting Assembly, 25 mm Insertion
9210012	pH 4.01 Buffer Solution, 16 oz
9210013	pH 6.86 Buffer Solution, 16 oz
9210014	pH 9.18 Buffer Solution, 16 oz



HIGH ACCURACY

measurement instruments

Our offering:

	<p>Pressure Measurement</p>		<p>Level Measurement</p>
	<p>Temperature Measurement</p>		<p>Flow Measurement</p>
	<p>Marine Measurement & Analytical</p>		<p>Gas Analysis</p>
	<p>Liquid Analysis</p>		<p>Flame and Gas Detection</p>
	<p>Tank Gauging</p>		<p>Wireless Infrastructure</p>
	<p>Acoustic & Discrete</p>		

www.high-accuracy.com

Global Headquarters

Emerson Automation Solutions

8200 Market Blvd
Chanhassen, MN 55317
+1 800 999 9307 or +1 952 906 8888
+1 952 949 7001
Liquid.CSC@Emerson.com

North America Regional Office

Emerson Automation Solutions

8200 Market Blvd.
Chanhassen, MN 55317, USA
+1 800 999 9307 or +1 952 906 8888
+1 952 949 7001
RMT-NA.RCCRFQ@Emerson.com

Latin America Regional Office

Emerson Automation Solutions

1300 Concord Terrace, Suite 400
Sunrise, FL 33323, USA
+1 954 846 5030
+1 954 846 5121
RFQ.RMD-RCC@Emerson.com

Europe Regional Office

Emerson Automation Solutions GmbH

Neuhofstrasse 19a P.O. Box 1046
CH 6340 Baar
Switzerland
+41 (0) 41 768 6111
+41 (0) 41 768 6300
RFQ.RMD-RCC@Emerson.com

Asia Pacific Regional Office

Emerson Automation Solutions Asia Pacific Pte Ltd

1 Pandan Crescent
Singapore 128461
+65 6777 8211
+65 6777 0947
Enquiries@AP.Emerson.com

Middle East and Africa Regional Office

Emerson Automation Solutions

Emerson FZE P.O. Box 17033,
Jebel Ali Free Zone - South 2
Dubai, United Arab Emirates
+971 4 8118100
+971 4 8865465
RFQ.RMTMEA@Emerson.com

 Analyticexpert.com

 [Linkedin.com/company/Emerson-Automation-Solutions](https://www.linkedin.com/company/Emerson-Automation-Solutions)

 [Twitter.com/Rosemount_News](https://twitter.com/Rosemount_News)

 [Facebook.com/Rosemount](https://www.facebook.com/Rosemount)

 [Youtube.com/user/RosemountMeasurement](https://www.youtube.com/user/RosemountMeasurement)

 [Google.com/+RosemountMeasurement](https://www.google.com/+RosemountMeasurement)

The Emerson logo is a trademark and service mark of Emerson Electric Co.
Rosemount and Rosemount logotype are trademarks of Emerson.
All other marks are the property of their respective owners.
© 2017 Emerson. All rights reserved.