



**HIGH ACCURACY**

m e a s u r e m e n t i n s t r u m e n t s

## PRODUCT DATASHEET

[www.high-accuracy.com](http://www.high-accuracy.com)

# Rosemount™ 499ADO

## Dissolved Oxygen Sensor



### A robust sensor for reliably measuring dissolved oxygen

The Rosemount™ 499ADO dissolved oxygen sensor is an easy to use amperometric sensor with a rugged construction. This sensor is ideal for measuring dissolved oxygen in aeration basins in municipal and industrial wastewater treatment plants.

# Overview



## Ease of Maintenance

- Extend sensor life with simple membrane and electrolyte replacement; no special tools required.
- Automatic temperature correction with integral Pt-100 RTD.
- Easy in-air calibration.

## Versatile Installation Options

- Forward and rear facing 1 in. MNPT process connections to meet a variety of application installation requirements.
- Installs in aeration basins and sidestream samples.
- Variopol (VP6) cable connector option eliminates cable twisting and allows for quick sensor replacement.

## High Performance Design

- Measures dissolved oxygen concentrations between 0 and 20 ppm.
- Operates in process temperatures up to 50 °C (122 °F).
- High accuracy of ±0.2 ppm at 25 °C (77 °F).

---

## Contents

Ordering Information .....	3
Specifications .....	4
Dimensional Drawings .....	5
Accessories .....	7

## Ordering Information



The Rosemount 499ADO dissolved oxygen sensor is ideal for measuring dissolved oxygen at the ppm level. Sensors can be immersed directly in aeration basins using the handrail mounting assembly or mounted in a variety of flow cells and flow through tees. The sensor is available with either an integral cable or Variopol (VP6) connector. Variopol cables are sold separately (see “Accessories”). Sensors come standard with three replacement membrane assemblies, three O-rings, and a 4 oz (125 mL) bottle of electrolyte.

**Table 1. Rosemount 499ADO Dissolved Oxygen Sensor Ordering Information**

Model	Sensor type
499ADO	Dissolved Oxygen Sensor
Transmitter compatibility	
54	For use with Rosemount 1056, 56, 1066, and 5081 transmitters

### Options

Cable options	
-	No selection - standard 25 ft cable
60	25 ft optimum EMI/RFI cable
VP	Variopol (VP6) connector <sup>1</sup>
Typical model number: 499ADO-54-VP	

1. For use with VP interconnecting cables (see “Accessories”).

## Specifications

### Sensor Specifications

**Range:** 0 to 20 ppm (mg/L) as O<sub>2</sub>. For measurements at the ppb level, choose 499ATrDO.

**Wetted parts:** Noryl<sup>1</sup>, Viton<sup>2</sup>, EPDM, Teflon<sup>3</sup> (TFE), and silicone

**Cathode:** Gold (not normally wetted)

**Accuracy:** ±0.2 ppm at 25 °C (77 °F)

**Repeatability:** ±0.5% of reading at 25 °C (77 °F)

**Response time:** <20 sec to 90% of final reading (0 to 2 ppm) at 25 °C (77 °F)

**Pressure:** 0 to 65 psig (101 to 549 kPa abs)

**Temperature:** 0 to 50 °C (32 to 122 °F)

**Process connection:** 1 in. MNPT

**Electrolyte volume:** 25 mL (approx.)

**Electrolyte life:** 4 to 6 months (approx.)

**Cable length (standard integral cable):** 25 ft (7.6 m)

**Cable length (maximum):** 300 ft (91 m)

#### Sample flow:

Flow through	1 to 5 gpm (3.8 to 19 L/min)
Open channel	1 ft/sec (0.3 m/sec)
Low flow cell	2 to 5 gph (7.6 to 19 L/hr)

Agitation produced by bubbles in aeration basins usually provides adequate flow.

**Weight/shipping weight:** 1 lb / 3 lb (0.5 kg / 1.5 kg)

1 Noryl is a registered trademark of General Electric.

2 Viton is a registered trademark of E.I. duPont de Nemours & Co.

3 Teflon is a registered trademark of E.I. duPont de Nemours & Co.

### Other Specifications

#### Low Flow Cell PN 24091-01

**Wetted parts:** Polycarbonate, polyester, 316 stainless steel, and silicone

**Process connection:** 1/4-in. OD tubing compression fitting or 1/4-in. FNPT

**Maximum pressure:** 90 psig (722 kPa abs)

**Maximum temperature:** 70 °C (158 °F)

**Note:** The temperature and pressure specifications for the low flow cell exceed the specifications for the sensor.

#### Flow-Through Tee (1-1/2 in. body) PN 23567-00

**Wetted parts:** CPVC and Buna N; body is schedule 80 CPVC.

**Process connection:** 1-1/2 in. socket

**Maximum pressure:** 65 psig (549 kPa abs)

**Maximum temperature:** 50 °C (122 °F)

#### Flow-Through Tee (2 in. body) PN 915240-03, 04, 05

**Wetted parts:** CPVC and Buna N; body is schedule 80 CPVC.

**Process connection:** 3/4 in. NFPT, 1 in. NFPT, or 1-1/2 in. NFPT

**Maximum pressure:** 65 psig (549 kPa abs)

**Maximum temperature:** 49 °C (120 °F)

#### Spray Cleaner PN 12707-00

**Wetted parts:** PVC, polypropylene, and 316 stainless steel

**Connection for cleaning fluid:** Compression fitting for 3/4 in. tubing

#### Valved Rotameter 9390004 for use with Low Flow Cell

**Flow:** 0.4 to 5 gph (1.5 to 19 L/hr)

**Wetted parts:** Acrylic, 316 stainless steel, and Viton

**Maximum pressure:** 100 psig (858 kPa abs)

**Maximum temperature:** 65 °C (150 °F)

## Dimensional Drawings

Figure 1. Rosemount 499ADO with Integral Cable Sensor Dimensions

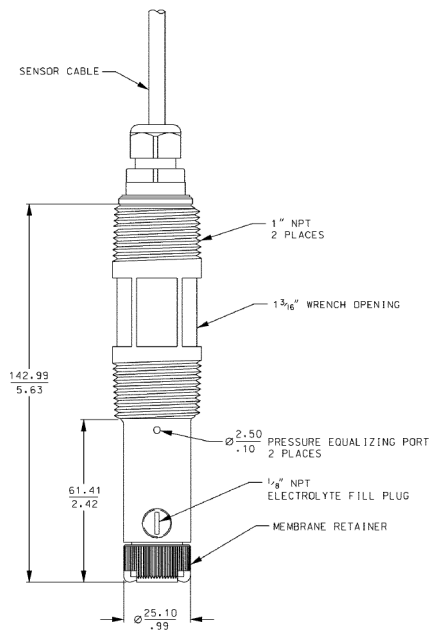

Figure 2. Rosemount 499ADO with Variopool Cable Connection Sensor Dimensions

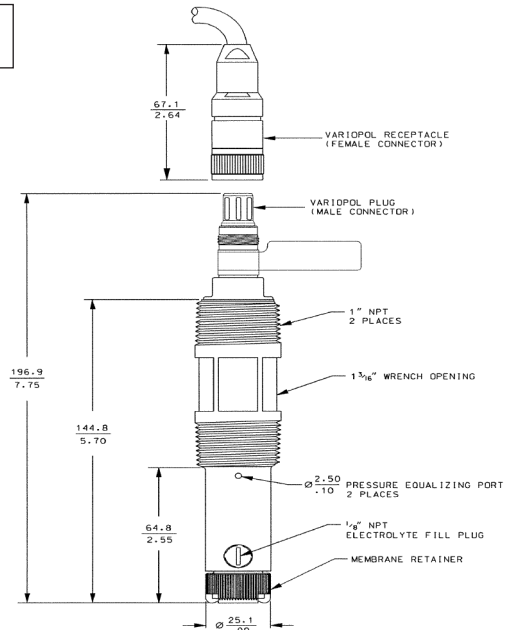

Figure 3. Low Flow Cell (PN 24091-00)

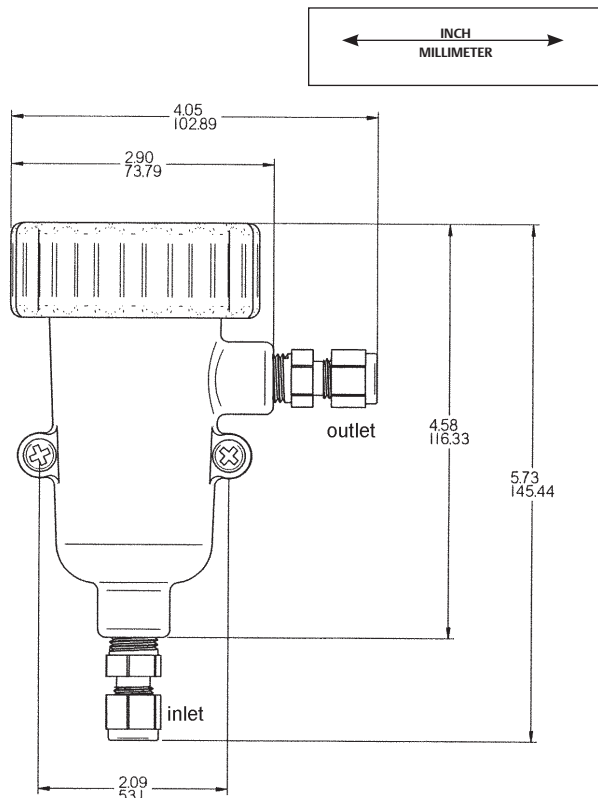

Figure 4. Flow-Through Tee (1-1/2 in.) (PN 23567-00)

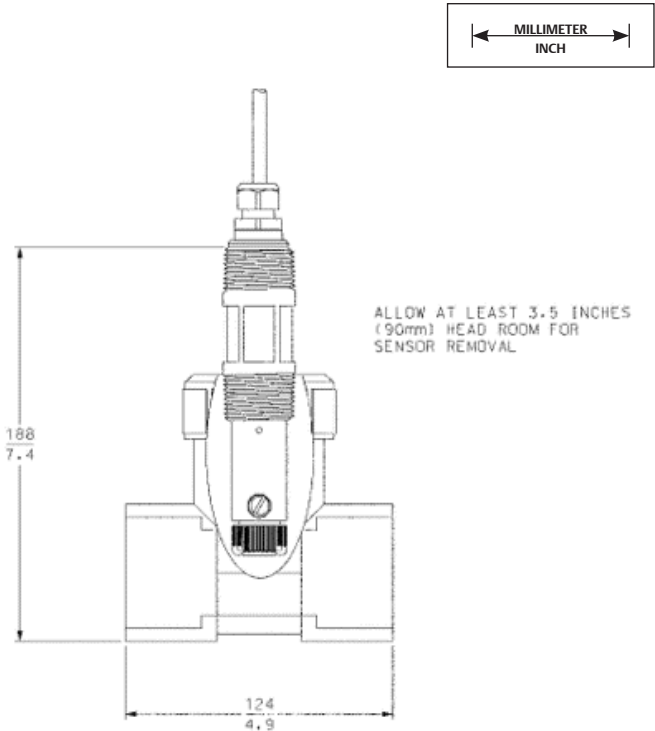
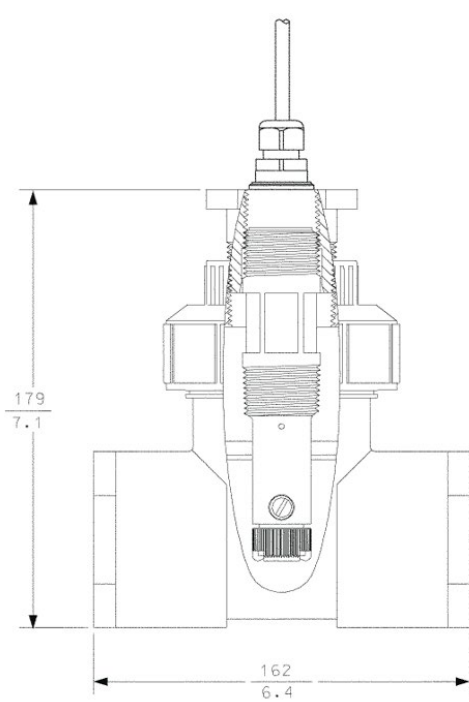

Figure 5. Flow-Through Tee (2 in.) (PN 915240-03, -04, -05)

Figure 6. Handrail Mounting Assembly (PN 11275-01)



ALLOW AT LEAST 6 INCHES (150mm) HEAD ROOM FOR SENSOR REMOVAL

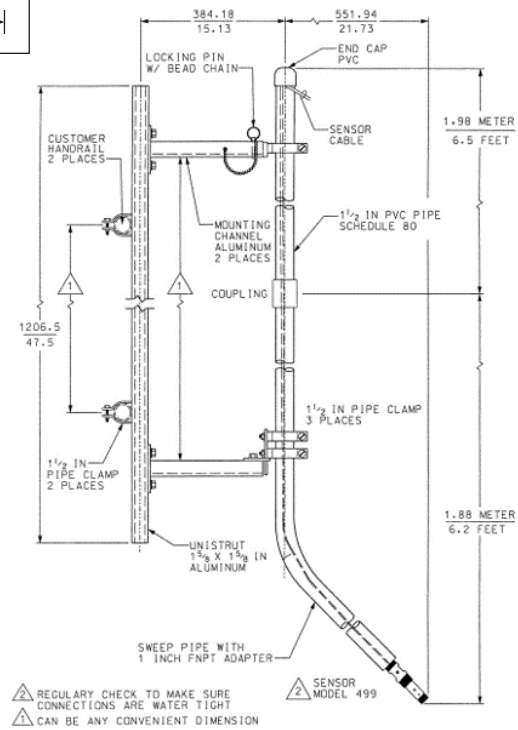
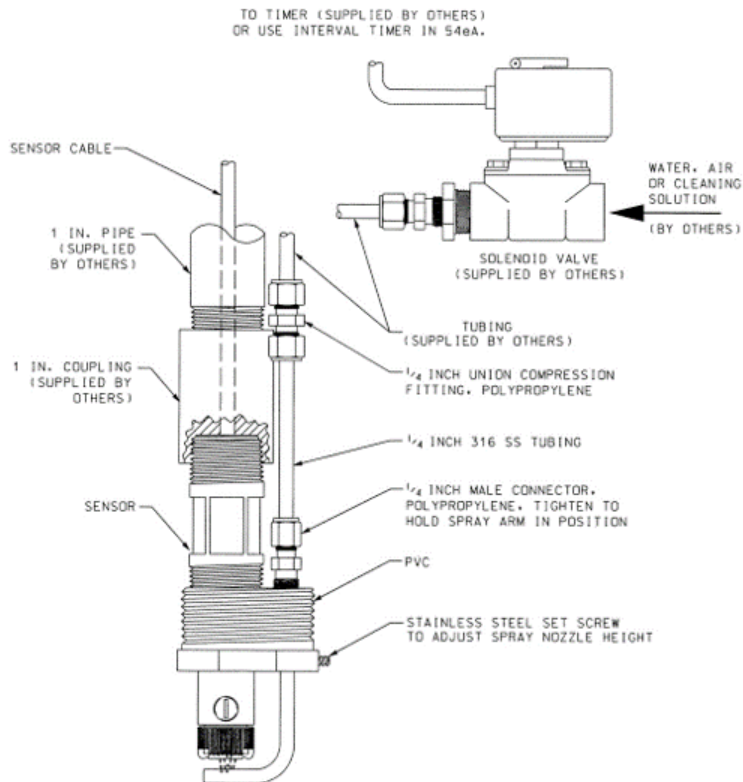

Figure 7. Jet Spray Cleaner (PN 12707-00)



## Accessories

Part number	Description
23567-00	1-1/2 in. flow through tee
914240-03	2 in. PVC flow through tee with 3/4 in. FNPT connections
914240-04	2 in. PVC flow through tee with 1 in. FNPT connections
915240-05	2 in. PVC flow through tee with 1-1/2 in. FNPT connections
23747-06	Interconnecting cable, VP 6, 2.5 ft. (0.8 m)
23747-04	Interconnecting cable, VP 6, 4 ft (1.2 m)
23747-02	Interconnecting cable, VP 6, 10 ft (3.0 m)
23747-07	Interconnecting cable, VP 6, 15 ft (4.6 m)
23747-08	Interconnecting cable, VP 6, 20 ft (6.1 m)
23747-09	Interconnecting cable, VP 6, 25 ft (7.6 m)
23747-10	Interconnecting cable, VP 6, 30 ft (9.1 m)
23747-03	Interconnecting cable, VP 6, 50 ft (15.2 m)
23747-11	Interconnecting cable, VP 6, 100 ft (30.5 m)
24091-00	Low flow cell
9390004	Rotameter: 0.5 - 5.0 gph
11275-01	Sensor handrail mounting assembly
12707-00	Jet spray cleaner
23550-00	Junction box without preamplifier
9200266	Extension cable for option -54 cable, unprepped
9200275	Extension cable for optimum EMI/RFI cable, unprepped
23747-00	Extension cable for optimum EMI/RFI cable, prepped
2001492	Stainless steel tag
23501-00	Dissolved oxygen membrane assembly: includes 1 membrane assembly and 1 O-ring.
23502-00	Dissolved oxygen membrane assembly: includes 3 membrane assemblies and 3 O-rings
9210264	Dissolved oxygen sensor fill solution, 4 oz (125 mL)
33521-02	Membrane retainer
33523-00	Fill plug

















# HA HIGH ACCURACY

measurement instruments



Our offering:

	<p>Pressure Measurement</p>		<p>Level Measurement</p>
	<p>Temperature Measurement</p>		<p>Flow Measurement</p>
	<p>Marine Measurement &amp; Analytical</p>		<p>Gas Analysis</p>
	<p>Liquid Analysis</p>		<p>Flame and Gas Detection</p>
	<p>Tank Gauging</p>		<p>Wireless Infrastructure</p>
	<p>Acoustic &amp; Discrete</p>		

[www.high-accuracy.com](http://www.high-accuracy.com)



### Global Headquarters

#### Emerson Automation Solutions

8200 Market Blvd.  
Chanhausen, MN 55317, USA  
 +1 800 999 9307 or +1 952 906 8888  
 +1 952 949 7001  
 Liquid.CSC@Emerson.com



### Latin America Regional Office

#### Emerson Automation Solutions

1300 Concord Terrace, Suite 400  
Sunrise, FL 33323, USA  
 +1 954 846 5030  
 +1 952846 5121  
 RFQ.RMD-RCC@Emerson.com

### Europe Regional Office

#### Emerson Automation Solutions Europe GmbH

Neuhofstrasse 19a P.O. Box 1046  
CH 6340 Baar  
Switzerland  
 +1 954 846 5030  
 +1 952846 5121  
 RFQ.RMD-RCC@Emerson.com



### Asia Pacific Regional Office

#### Emerson Automation Solutions Asia Pacific Pte LTD

1 Pandan Crescent  
Singapore 128461  
 +65 6777 8211  
 +65 6777 0947  
 Enquiries@AP.Emerson.com

### Middle East and Africa Regional Office

#### Emerson Automation Solutions

Emerson FZE P.O. Box 17033  
Jebel Ali Free Zone - South 2  
 +971 4 8118100  
 +971 4 88665465  
 RFQ.RMTMEA@Emerson.com



[Analyticexpert.com](http://Analyticexpert.com)



[Linkedin.com/company/Emerson-Automation-Solutions](https://www.linkedin.com/company/Emerson-Automation-Solutions)



[Twitter.com/Rosemount\\_News](https://twitter.com/Rosemount_News)



[Facebook.com/Rosemount](https://www.facebook.com/Rosemount)



[Youtube.com/user/RosemountMeasurement](https://www.youtube.com/user/RosemountMeasurement)



[Google.com/+RosemountMeasurement](https://www.google.com/+RosemountMeasurement)

The Emerson logo is a trademark and service mark of Emerson Electric Co.  
Rosemount and Rosemount logotype are trademarks of Emerson.  
All other marks are the property of their respective owners.  
© 2017 Emerson. All rights reserved.