



HIGH ACCURACY

m e a s u r e m e n t i n s t r u m e n t s

PRODUCT DATASHEET

www.high-accuracy.com

| Technical Specification: | |
|--|--|
| Max measurement points per cabinet | 10 Electro-pneumatic measurement points 12 analog 4-20mA inputs (optional) |
| Measurement range | 0-35 mH ₂ O |
| Sensor accuracy | 0.1 % F.S. including non-linearity, repeatability, hysteresis and temperature error |
| Overpressure capability | 8 bar |
| Communication interface | RS-485 (x1 or x2) Modbus (RTU) |
| Operating temperature | 0 - +55°C |
| Storage temperature | -50 - +60°C |
| Humidity | No condensation |
| IP rating | IP 54, Safe area |
| Power | 230/115 VAC, 50-60 Hz; 24 VDC |
| Power consumption | Max 13W AC supply; 30W DC supply |
| Air supply | Dry and clean instrument air, approx. 7 bar |
| Air consumption (for each measurement point) | Empty tank 0.5 l/min (free air) 0,07 l/min (7 bar air) 10m level 0.85 l/min (free air) 0,12 l/min (7 bar air) 20m level 1.2 l/min (free air) 0,17 l/min (7 bar air) 30m level 1.4 l/min (free air) 0,20 l/min (7 bar air) |
| Dimensions (Height x Width x Depth) | 400 x 520 x 220 mm / cabinet |
| Weight | 27 kg / cabinet |
| Standard painting | RAL 7032 |
| Pneumatic pipe connections (thread) | ISO 228/1-G1/4 (female) |

The Emerson logo is a trademark and service mark of Emerson Co. SF-Control and the LevelDatic logotype are registered trademarks of SF-Control OY. All rights reserved. The content of this publication are presented for information purposes only, and while efforts have been made to ensure their accuracy, they are not to be construed as warranties or guarantees, expressed or implied, regarding the products or services described herein or their use or applicability. All sales are governed by our terms and conditions, which are available upon request. We reserve the right to modify or improve the designs or specifications of our products at any time without notice. SF-Control OY accepts no responsibility for any errors that may appear in this publication.

This product is developed and managed by:
Marine Tank Management
Emerson Process Management
SF-Control OY
 Valimotie 13B
 FI-00380 Helsinki, Finland
 T +358 9 756 234 10
 F +358 9 757 2778

For global contacts:
www.EmersonProcess.com/mtm

System Description - LevelDatic 120S

Benefits

- Accurate and robust measurement in all types of tanks
- No electronics in hazardous area, easy exchange of electronics
- Reference pressure for each measurement channel, facilitating measurement in tanks with different top pressure

The electro-pneumatic LevelDatic 120S system provides reliable and accurate continuous on-line information on actual tank levels, possible water ingress and ship's draft. Every tank, hold, void space and draft measurement has its own dedicated sensor.

All sensors are located in cabinets in a safe area. There are no sensors, electrical cables or moving parts in the tanks that can be damaged, and that require tank entry for replacement.

Product Description

LevelDatic 120S calculates level or draught measurement from hydrostatic pressure using electro-pneumatic technology.

Two main methods are being used to measure hydrostatic pressure:

- *Sounding pipe* — used in tanks where bubbling air is fed into the tanks, such as ballast tanks, diesel oil tanks, day tanks, heavy fuel oil tanks and draught measurement.
- *Pneumatic 1:1 pressure converter* — used where air fed into the tanks is prohibited, such as in drinking water tanks.



Accurate control of air flow is important for reliability.

The system measures the pressure signal and calculates a digital value. The digital value can be further refined by compensating for trim/list and volume.

10 electro-pneumatic channels can be connected to each cabinet and additional cabinets can be added to fit the vessel's requirement. A unique feature is that each channel has a built in non-return valve in the pneumatic block which is located in the cabinet.

Other applications

LevelDatic 120S can also be used to monitor dry or void spaces.

Increased robustness with smart sensors

The system uses piezoresistive pressure sensors, with good accuracy, excellent long term stability, repeatability and capability to handle overpressure from sloshing.

The smart sensor compensates for temperature variations as well as measurement point offsets. The advantages of this compensation is excellent linearity and measurement accuracy.

Each measurement channel has its own atmospheric reference sensor. The differential pressure, compensated for pipeline resistance, provides the tank hydrostatic pressure and thus an accurate liquid level is calculated. As each channel has its own reference pressure, the system can handle tanks with different top pressure, e.g. in ballast water exchange systems.

Each electro-pneumatic measurement channel has an optional 4-20 mA output signal, which can be used instead of the digital signal.

Information display

The information display located at the heart of the system is a complement and offers a window into the system for monitoring of measured data.

From the display it is possible to monitor values and check the status of the system.



Host computer

The LevelDatic 120S can be connected to a host computer or other display devices such as a remote display unit or a loading computer. To accommodate this, the system is equipped with a gateway module handling the data transfer.

To further increase the system fault tolerance the external and internal communication links can be duplicated.

The physical interface to the system can be LAN or serial communication.

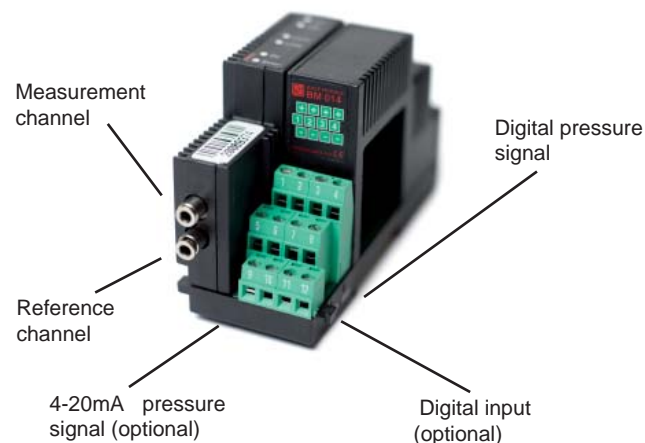

Installation flexibility

Depending on possible entry access to a tank, the air pipe can be entered from either the top or the side. To avoid back flow of tank contents, an additional non-return valve can be fitted onto the pipe.

The atmospheric pressure is connected to the system by a venting pipe, used as reference pressure when calculating the liquid level. If a tank is pressurized, an additional pipe can be connected to measure the tank top pressure.

If air bubbling is not permitted in the tank due to the liquid property, a 1:1 converter can be fitted.

The draft is measured by feeding a pipe through the bottom of the ship hull.

Optional generic analog 4-20 mA output/input signals can be added e.g. inclinometer for trim and list compensation or conventional pressure transmitters.

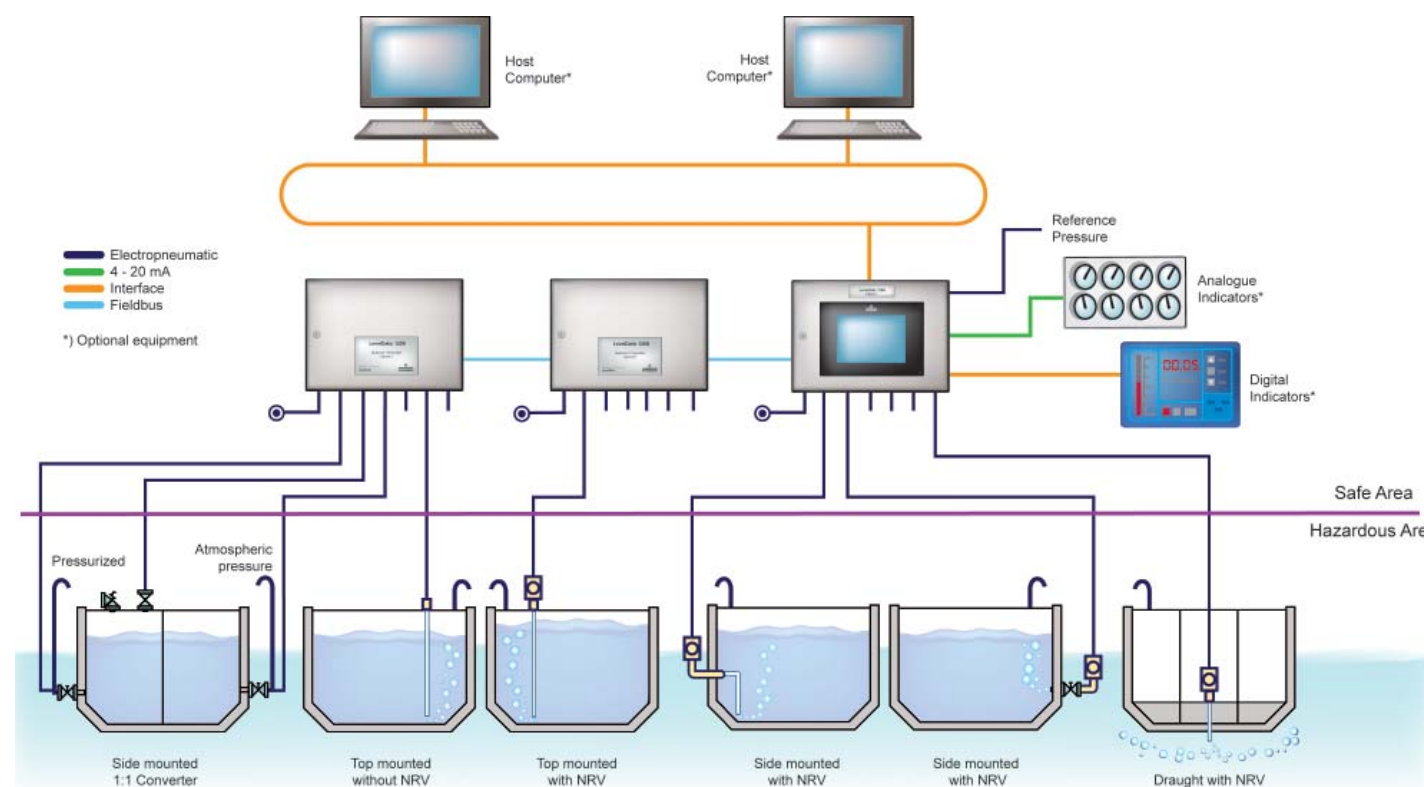









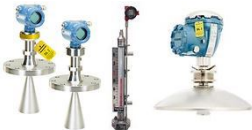



HIGH ACCURACY

measurement instruments

Our offering:

| | | | |
|---|--|--|------------------------------------|
|  | <p>Pressure Measurement</p> |  | <p>Level Measurement</p> |
|  | <p>Temperature Measurement</p> |  | <p>Flow Measurement</p> |
|  | <p>Marine Measurement & Analytical</p> |  | <p>Gas Analysis</p> |
|  | <p>Liquid Analysis</p> |  | <p>Flame and Gas Detection</p> |
|  | <p>Tank Gauging</p> |  | <p>Wireless Infrastructure</p> |
|  | <p>Acoustic & Discrete</p> |  | |

www.high-accuracy.com