



HIGH ACCURACY

m e a s u r e m e n t i n s t r u m e n t s

PRODUCT DATASHEET

www.high-accuracy.com

Net Safety™ Millennium Air Particle Monitor (APM)

The Net Safety™ Millennium Air Particle Monitor (APM) is the only infrared optical monitor that is certified for use in hazardous areas for constant, reliable monitoring of ambient air for products of combustion such as smoke, oil mist, carbon, dust, and ash.

This unique product is explosion proof—ideally suited for a wide variety of industrial applications. Proven installed base includes Class I, Division 1 areas requiring accurate air particle monitoring such as air ducts, battery rooms, engine rooms, compressor stations, offshore living quarters, and HVAC air intake points.

- Explosion-proof, Class I, Division/Zone 1 approved
- Operating temperature range -40 °F to 167 °F (-40 °C to 75 °C)
- 4–20 mA analog and relay output configurations
- Remote sensor separation - 2,000 ft (600 m) and a variety of duct mount assemblies available
- Intuitive menu system, zero in 60 seconds from start to finish
- Field adjustable sensitivity settings
- Not affected by high volume air velocity
- Multi-language, bright scrolling LED display allows operators to fine tune at installation site.

The advanced sensor design has several performance features; it uses a powerful infrared lamp and no mirrors, making the optics resilient to the adverse effect of dirt. The instrument's field adjustable zero level of obscuration and multiple sensitivity settings allow for fine tuning to optimize performance and eliminate false alarms. Additionally, the sensor can be equipped with a duct mounting kit, pipe mounting kit, and pipe extensions to suit many applications.



Millennium Air Particle Monitor (APM)

The Millennium Series controller is an innovative line of explosion proof industrial detectors. Its microcontroller provides fast, accurate, and continuous monitoring in hazardous area environments. The 4–20 mA analog signal and FORM-C mechanical relays easily integrate into industrial safety systems. The compact controller with power disconnect switch simplifies maintenance, a scrolling LED simplifies calibration and configuration, while meter jacks facilitate current loop monitoring.

The Net Safety Millennium APM is market proven within a variety of specialized applications worldwide, providing superior performance and effectiveness.

Applications

Gas compressor stations, FSPO/tanker hull chambers, gas turbine engine enclosures, marine battery rooms, engine rooms, duct monitoring, chemical storage, industrial manufacturing, and HVAC systems.

Specifications

Table 1 - Millennium Air Particle Monitor (APM)

Millennium APM sensor specifications	
Temperature range	-40 °F to 167 °F (-40 °C to 75 °C)
Weight	Stainless steel: 4.0 lb (1.8 kg)
Enclosure Material	Stainless steel (SS316)
Certifications	<p>North America Class I, Division 1, Groups B, C, and D T5 AEx d IIB+H2 T5 (Class I, Zone 1, Groups IIB+H2 T5) ATEX (-X Model) CE 1180 Ex 2 G, Ex db op is IIB+H2 T4 Gb -40 °C to +75 °C, IP65 IECEX (-X Model) Ex db op is IIB+H2 T4 Gb -40 °C to +75 °C, IP65</p>
Sensor warranty	Two years

Millennium transmitter/controller	
Operating voltage range	10.5 to 32.0 Vdc
Power consumption	150 mA (3.6 W) at 24 Vdc
Operating temperature and humidity range	-40 °F to +185 °F (-40 °C to +85 °C) 0 to 95 % relative humidity, non-condensing
Output(s)	<p>Analog 4–20 mA: Max. loop impedance of 800 ohms at 32 Vdc or 150 ohms at 10.5 Vdc. Isolated or non-isolated loop supply</p> <p>Relays: Three FORM-C contacts for Fault, window condition, and alarm status. Rated 5 A at 30 Vdc/250 Vac energized/de-energized, latching/non-latching</p>
Enclosure material	Stainless steel (SS316)
Weight	Stainless steel: 7.0 lb (3.2 kg)
Warranty	Three years
Alphanumeric display	Bright 8-digit LED scrolling type display - English, French, and Spanish languages available
Unique features	Local power switch and meter test jacks on faceplate for easy maintenance Easy to read instructions for one-person, non-intrusive calibration
Certifications	<p>North America Class I, Division 1, Groups BCD, T4A Ex d IIB+H2 T5 (Class I, Zone 1 Group IIB+H2 T5) Type 4X ATEX (-X Model) CE 1180 Ex IIG Ex d IIB+H2 T5 IP66 -40 °C to +85 °C IECEX (-X Model) Ex d IIB+H2 T5 Gb -40 °C to +85 °C</p>

Table 2 - Ordering Information

MLP-AR-APM-OP-SEP-SS	4–20 mA and relay outputs, APM sensor with separation box included	Additional approvals: -X (ATEX/IECEX)
----------------------	--	---------------------------------------

Specifications Continued

Table 2 - Accessories

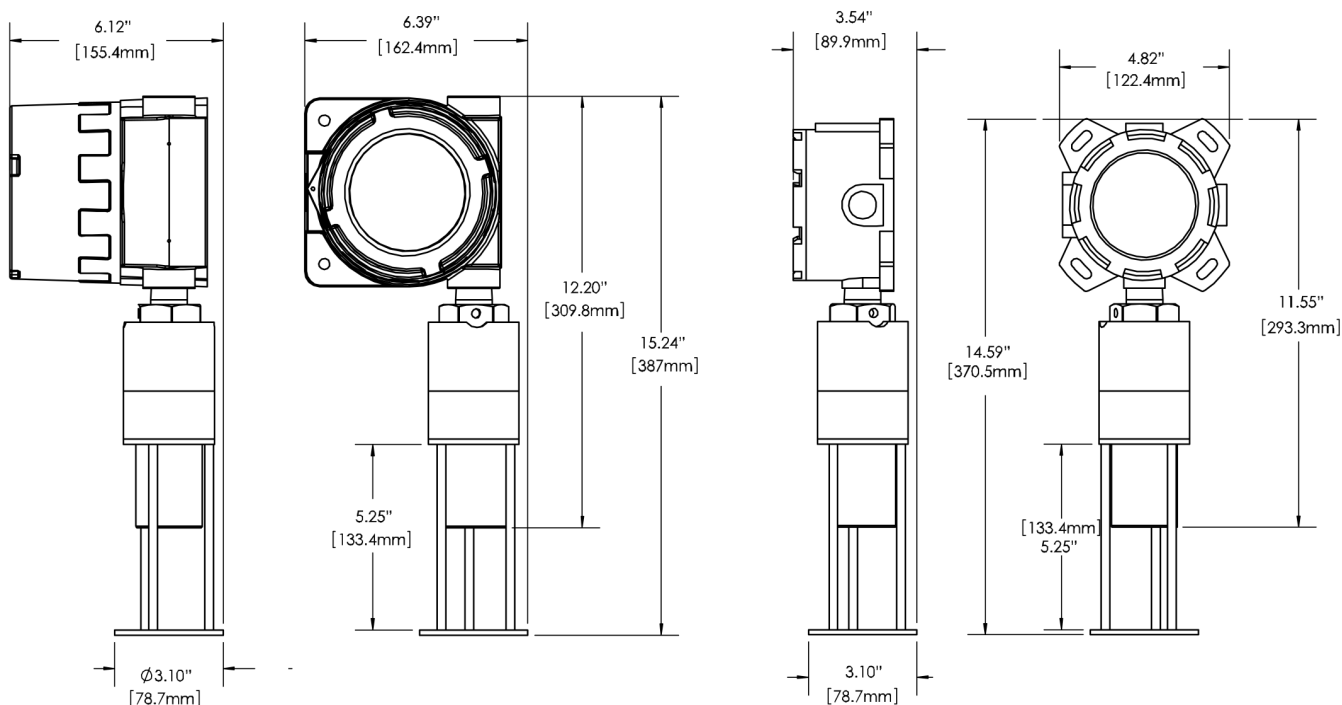













Accessories	
UN-MK-31	1-in. (25.4 mm) pipe mounting kit - stainless steel
UN-MK-32	2-in. (50.8 mm) pipe mounting kit - stainless steel
UN-MK-33	3-in. (76.2 mm) pipe mounting kit - stainless steel
SSK-51	1-in. (25.4 mm) pipe mounted sunshade kit/rain guard, stainless steel - includes UN-MK-31
SSK-52	2-in. (50.8 mm) pipe mounted sunshade kit/rain guard, stainless steel - includes UN-MK-32
SSK-53	3-in. (76.2 mm) pipe mounted sunshade kit/rain guard, stainless steel - includes UN-MK-33
UDM-001	Universal duct mount assembly with 1 m inlet sampling pipe, stainless steel
UDM-002	Universal duct mount assembly with 1.5 m inlet sampling pipe, stainless steel
UDM-003	Universal duct assembly, stainless steel
UDM-EX1	3.3 ft (1 m) extension - for use with UDM-001 and UDM-002, stainless steel
UDM-EX2	4.9 ft (1.5 m) extension - for use with UDM-001 and UDM-002, stainless steel



HA HIGH ACCURACY

measurement instruments

Our offering:

	<p>Pressure Measurement</p>		<p>Level Measurement</p>
	<p>Temperature Measurement</p>		<p>Flow Measurement</p>
	<p>Marine Measurement & Analytical</p>		<p>Gas Analysis</p>
	<p>Liquid Analysis</p>		<p>Flame and Gas Detection</p>
	<p>Tank Gauging</p>		<p>Wireless Infrastructure</p>
	<p>Acoustic & Discrete</p>		

www.high-accuracy.com



Global Headquarters

Emerson Automation Solutions

6021 Innovation Blvd.
Shakopee, MN 55379, USA
 +1 800 999 9307 or +1 952 906 8888
 +1 952 949 7001
 Safety.CSC@Emerson.com



North America Regional Office

Emerson Automation Solutions

8200 Market Blvd.
Chanhassen, MN 55317, USA
 +1 800 999 9307 or +1 952 906 8888
 +1 952 949 7001
 RFQ-NA.RCCRFQ@Emerson.com

Latin America Regional Office

Emerson Automation Solutions

1300 Concord Terrace, Suite 400
Sunrise, FL 33323, USA
 +1 954 846 5030
 +1 952846 5121
 RFQ.RMD-RCC@Emerson.com

Europe Regional Office

Emerson Automation Solutions Europe GmbH

Neuhofstrasse 19a P.O. Box 1046
CH 6340 Baar
Switzerland
 +1 954 846 5030
 +1 952846 5121
 RFQ.RMD-RCC@Emerson.com



Asia Pacific Regional Office

Emerson Automation Solutions Asia Pacific Pte LTD

1 Pandan Crescent
Singapore 128461
 +65 6777 8211
 +65 6777 0947
 Enquiries@AP.Emerson.com

Middle East and Africa Regional Office

Emerson Automation Solutions

Emerson FZE P.O. Box 17033
Jebel Ali Free Zone - South 2
 +971 4 8118100
 +971 4 88665465
 RFQ.RMTMEA@Emerson.com



Analyticexpert.com



[Linkedin.com/company/Emerson-Automation-Solutions](https://www.linkedin.com/company/Emerson-Automation-Solutions)



[Twitter.com/Rosemount_News](https://twitter.com/Rosemount_News)



[Facebook.com/Rosemount](https://www.facebook.com/Rosemount)



[Youtube.com/user/RosemountMeasurement](https://www.youtube.com/user/RosemountMeasurement)



[Google.com/+RosemountMeasurement](https://plus.google.com/+RosemountMeasurement)

The Emerson logo is a trademark and service mark of Emerson Electric Co.
Rosemount and Rosemount logotype are trademarks of Emerson.
All other marks are the property of their respective owners.
© 2018 Emerson. All rights reserved.