



**HIGH ACCURACY**

m e a s u r e m e n t i n s t r u m e n t s

## PRODUCT DATASHEET

[www.high-accuracy.com](http://www.high-accuracy.com)

# ST3 XChem Toxic Gas Sensors

## Millennium II Series Sensors

The ST3 XChem series of electrochemical toxic gas sensors provide high specificity, fast response, and long life. All ST3 sensors are part of the universal Millennium II Gas Detection platform and are compatible with the M21, M22, and M2B transmitters. Our latest design employs our “SimpleClick” sensor element design and low power consumption.

- Sensor end of life diagnostic
- Plug and play design where the transmitter automatically recognizes sensor configuration
- Low power consumption increases uptime
- Two year warranties available on most sensors
- Field selectable gas ranges
- Designed to perform in the most extreme industrial environments

### Sensor End of Life Diagnostic

As part of the normal lifecycle of an electrochemical sensor the sensor is required to be monitored and replaced on a regular basis. The end of life diagnostic automatically determines the health of the electrochemical sensor cell and provides a fault condition alerting the user the sensor needs to be replaced.

### Single or Dual Channel Transmitter Available

There is no longer the need to purchase multiple gas specific detectors. You have the option to use one or two toxic or combustible gas sensors on a single Millennium II transmitter and easily mix and match any type of sensor in the Millennium II platform.

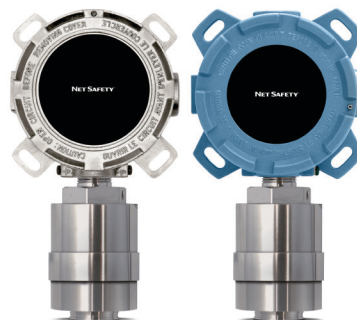

ST3 Sensors shown with JB-MPD-A/S.

### Plug and Play Design

The ST3 XChem series sensors are pre-calibrated and easily connected to a transmitter that recognizes a newly fitted sensor, uploading its specific configuration profile.

### Improved Triple Electrode Design

Robust material on sensing, reference, and counter electrodes within the ST3 sensing element ensure long life and enhanced performance.

### Advanced Environmental Immunity

ST3 XChem toxic gas sensors are temperature compensated to their target gas and field selected gas concentration range to provide an accurate and stable gas concentration reading. Humidity is also controlled through the use of an advanced diffusion process as gases pass through our specialized hydrophobic barrier.

## Specifications

**Table 1 - ST3 XChem Toxic Gas Sensor**

Hydrogen Sulfide [H <sub>2</sub> S] (Electrochemical) P/N: ST320(A/S)-100-ASSY		Carbon Monoxide [CO] (Electrochemical) P/N: ST360(A/S)-1000-ASSY	Oxygen [O <sub>2</sub> ] Deficiency (Electrochemical) P/N: ST341(A/S)-25-ASSY
<b>Performance</b>			
Response Time (without accessories)	T20: 10 s T50: 15 s T90: 36 s	T20: 10 s T50: 15 s T90: 30 s	T20: 7 s T50: 10 s T90: 20 s
Accuracy	0 °C to +50 °C (+32 °F to +122 °F) ±6 ppm or 17 % of reading, whichever is greater  -40 °C to 0 °C (-40 °F to +32 °F) ±7 ppm or 27 % of reading, whichever is greater	0 °C to +50 °C (+32 °F to +122 °F) ±13 ppm or 5 % of reading, whichever is greater  -20 °C to 0 °C (-4 °F to +32 °F) ±32 ppm or 17 % of reading, whichever is greater	±0.5 % vol.
Detection Range	0–20/50/100 ppm (Field Selectable)	0–500/1000 ppm (Field Selectable)	0–25 % vol.
Zero Drift	< 5 % full scale per year		
Repeatability	< 3 % full scale		
Calibration Frequency	3 months		
Shelf Life	6 months		
<b>Environmental</b>			
Operating Temperature	-40 °C to +50 °C (-40 °F to +122 °F)	-20 °C to +50 °C (-4 °F to +122 °F)	
Storage Temperature	+3 °C to +20 °C (+37 °F to +68 °F)		0 °C to +20 °C (+32 °F to +68 °F)
Relative Humidity	15–90 % RH non condensing		
Ingress Protection (IP) Rating	IP64		
<b>Enclosure</b>			
Weight	Stainless Steel: 3.5 lbs (1.4 kg) Aluminum: 1 lb (0.4 kg)		
Enclosure Material	Aluminum (AL6061) or stainless steel (SS316)		
<b>Certifications</b>	<b>North American</b>  Class I Division 1 Groups BCD T5 Ex d IIB+ H <sub>2</sub> T5 Class I Zone 1 AEx d IIB +H <sub>2</sub> T5 IP64  <b>IECEX</b> Ex d IIB+H <sub>2</sub> T5 Gb IP64		
<b>EMC Compliance</b>	EN 50270:2006		
<b>Sensor Separation</b>	Up to 2,000 feet/600 meters (18 AWG cabling)		
<b>Transmitter Required</b>	Millennium II Series (M21, M22, M2B)		For use with the M21-AH-A/S or M21-AHR-A/S only
<b>Warranty</b>	Two years		

## Drawings and Dimensions

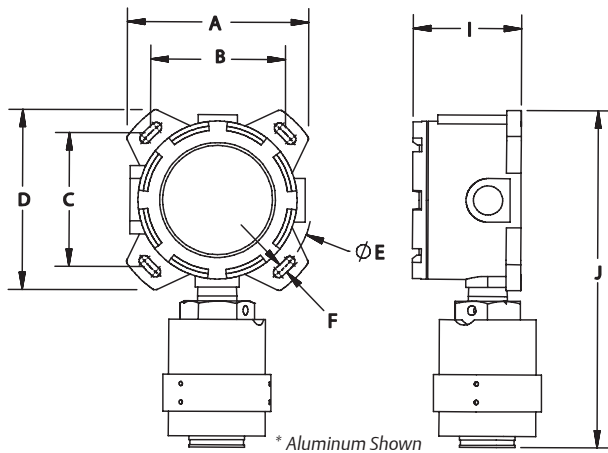

Table 2 - ST3 XChem Toxic Gas Sensor

	A		B		C		D		E	
Aluminum Housings	6.3	160	5.6	142	5.4	137	9.7	246	6.0	152
Stainless Steel Housings	5.9	150	5.1	130	4.6	117	8.9	226	6.0	152
	F		G		H		I			
Aluminum Housings	5.7	145	2.6	66	2.9	74	4.1	103		
Stainless Steel Housings	5.8	147	2.6	66	2.9	74	3.9	100		

## Accessories and Ordering Information

Table 3 - ST3 XChem Toxic Gas Sensor

<b>JB-MPD-S</b>	Termination Box - Digital Output - Stainless Steel
<b>JB-MPD-A</b>	Termination Box - Digital Output - Stainless Steel
<b>CCS-1</b>	Calibration Cup/Rain Shield/Splash Guard/Dust Filter with DF-1
<b>DSC-1</b>	Dust/Sand protective clip (includes DF-1 disposable filter)
<b>IPF-001</b>	IP 66/67 Filter for SX3 Series sensors, enhanced sensor protection from contamination by dirt and moisture

### Order Information

**ST320A-100-ASSY (ST320S-100-ASSY Stainless Steel)**  
Hydrogen Sulfide [H<sub>2</sub>S], 0–20/50/100 ppm Field Selectable

**ST341A-25-ASSY (ST341S-25-ASSY Stainless Steel)**  
Oxygen [O<sub>2</sub>] Deficiency, 0–25 % By Volume













**ST360A-1000-ASSY (ST360S-1000-ASSY Stainless Steel)**  
Carbon Monoxide [CO], 0–500/1000 ppm Field Selectable



# HIGH ACCURACY

measurement instruments

Our offering:

	<p>Pressure Measurement</p>		<p>Level Measurement</p>
	<p>Temperature Measurement</p>		<p>Flow Measurement</p>
	<p>Marine Measurement &amp; Analytical</p>		<p>Gas Analysis</p>
	<p>Liquid Analysis</p>		<p>Flame and Gas Detection</p>
	<p>Tank Gauging</p>		<p>Wireless Infrastructure</p>
	<p>Acoustic &amp; Discrete</p>		

[www.high-accuracy.com](http://www.high-accuracy.com)

**EmersonProcess.com/FlameGasDetection**

 YouTube.com/user/RosemountAnalytical

 Analyticexpert.com

 Twitter.com/Rosemount\_News

 Facebook.com/Rosemount

**Americas**

**Emerson Process Management**

6021 Innovation Blvd.  
Shakopee, MN 55379  
USA

T + 1 866 347 3427  
F + 1 952 949 7001

**Safety.CSC@Emerson.com**

**Europe**

**Emerson Process Management AG**

Neuhofstrasse 19a P.O. Box 1046  
CH-6340 Baar  
Switzerland

T + 41 (0) 41 768 6111  
F + 41 (0) 41 768 6300

**Safety.CSC@Emerson.com**

**Middle East & Asia**

**Emerson Process Management**

Emerson FZE  
Jebel Ali Free Zone  
Dubai, UAE  
P.O. Box 17033

T + 971 4 811 8100  
F + 971 4 886 5465

**Safety.CSC@Emerson.com**

**Asia Pacific**

**Emerson Process Management**

1 Pandan Crescent  
Singapore 128461  
Singapore

T + 65 777 8211  
F + 65 777 0947

**Safety.CSC@Emerson.com**

©2016 Emerson Process Management. All rights reserved.

The Emerson logo is a trademark and service mark of Emerson Electric Co. Rosemount and the Rosemount logotype are registered trademarks of Rosemount Inc. All other marks are the property of their respective owners.

The contents of this publication are presented for information purposes only, and while effort has been made to ensure their accuracy, they are not to be construed as warranties or guarantees, express or implied, regarding the products or services described herein or their use or applicability. All sales are governed by our terms and conditions, which are available on request. We reserve the right to modify or improve the designs or specifications of our products at any time without notice.